

INTERIOR MOULDING & TRIM



METRIE.

THE ART OF FORM





METRIE.

THE ART OF FORM

WHO WE ARE

Since our beginnings as a small family-owned business in 1926, our dedication to creating high-quality, finely crafted architectural elements has helped us grow to become the largest supplier and manufacturer of solid wood and composite moulding in North America.

METRIE.COM

DESIGN – PARTNERSHIP – CRAFTSMANSHIP



Our success is driven by a commitment to deliver excellence rooted in design, partnership and craftsmanship.

We believe beauty is in the details, and know that even the smallest of details adds up to create big differences.

Design is in our DNA, and permeates many aspects of our business. Our teams work on everything from trend forecasting to creating new profiles that meet the needs of our customers and homeowners.

We design and craft relationships you can count on – partnerships you can rely on. We collaborate with our partners while listening and talking to designers, architects, builders and contractors – adding value throughout the supply chain.



Our attention
to the details
helps people
create beautiful
interior spaces.
Spaces to live,
work and to truly
call home.



FIND US, FOLLOW US, LIKE US & WATCH US!



MANUFACTURING EXCELLENCE

Metrie operates five domestic manufacturing facilities between the U.S. and Canada. Our solid and finger-jointed wood mills are located close to their respective fiber sources to minimize the costs and environmental impacts of transportation while ensuring that all raw materials are responsibly sourced. Our state-of-the-art MDF mills are technologically advanced and designed for efficient operations, reflecting our customer commitment to delivering finely crafted, high quality products.



UNMATCHED QUALITY

Our mills allow us the flexibility to provide the right solutions to the markets we serve, understanding regional differences and adhering to strict specification standards. In addition, we have the ability to design, test and produce exclusive profiles to satisfy a custom order or to stay on top of the latest home trends. We have full in-house CAD capabilities and use computer-generated templates to manufacture profiles to extremely tight tolerances. Metrie has built a reputation for setting some of the highest industry standards.



RESPONSIBLE ACTIONS

With fine craftsmanship comes responsibility, and we are committed to being responsible stewards of forest resources. We strive to maximize the yield from every board using variable width and multiple rip-saws. Our resaws use ultra-thin blades to minimize saw kerf and any products that do not meet our length criteria are manufactured into finger-joint blocks to eventually become finger-jointed mouldings.



TheFinishedSpace.com



Facebook.com/OfficialMetrie



Twitter.com/OfficialMetrie



Instagram.com/OfficialMetrie



LinkedIn.com/Company/Metrie



Pinterest.com/OfficialMetrie



YouTube.com/OfficialMetrie



Houzz.com/pro/Metrie

TABLE of Contents

- 6 Architraves
- 7 Back Bands
- 8 Baseboards
- 19 Baseboard Caps & Shoes
- 20 Casings
- 30 Chair Rails
- 32 Corner Guards
- 33 Coves
- 34 Crowns
- 42 Door Stops
- 44 Flat Stock
- 46 Jambs
- 47 Miscellaneous
- 56 Notes
- 57 Index



Storage, Handling and Preparation of all Mouldings and S4S Boards

Prior to installation, it is important to acclimate your moulding and trim products by storing them in the installation space for at least 3 days. Wood and wood based products can expand and contract depending on internal and external environmental moisture levels. For best results, be sure to store products in a dry location and transport only if fully protected from water. Keep products clean from dirt and debris and finish according to paint and stain manufacturers' recommendations.



- 1 **ARCHITRAVES:** In classical architecture, it described the main beam resting on the tops of the columns. Today it is often used as a decorative moulding for ornamentation or finishing at the top of windows and doors.
- 2 **BASEBOARDS:** Baseboards are placed along the wall at the floor. They should be chosen to work in harmony with your casings to finish and tie the room together. Baseboards are usually thinner than the casing.
- 3 **BUILD-UPS:** Combining two or more moulding profiles to create a new or custom look. Also called stacking, build-ups make it easy to create the look of custom made trimwork without the high cost.
- 4 **CASINGS:** Casings define the overall character of a room and are often the most visible part of the trim. They are used primarily to cover the gap between drywall and the door or window frame. Casings are generally thicker than the base mouldings.
- 5 **CROWNS:** Crowns are placed along the wall at the ceiling. They come in a wide range of patterns and sizes. Crowns soften the transition from wall to ceiling while adding a distinctive look and charm to your room.
- 6 **FINISH BOARDS:** Finish Boards come in either S4S (Surfaced 4 Sides) or S3S (Surfaced 3 Sides) and are used for a multitude of purposes including shelving, window liner, bases, casing, etc.
- 7 **PANEL MOULDS:** Panel Moulds are used to frame wall paneling and add an accent to your walls. Often used in furniture construction.
- 8 **RAKE MOULD:** Rakes are often used as crowns. In fact, they are sometimes called "solid crowns".
- 9 **WAINSCOT:** Trimwork installed in the area below a chair rail. Numerous options are available including raised panel, shadow box and beaded. Combined with a chair rail and baseboard, Wainscoting creates a dramatic look to any room.
- 10 **WINDOW STOOL:** Also called window sill, a Window Stool is the surface installed below the sash of a window. Trim installed under window stool creates a distinctive look and adds a decorative touch.

ARCHITRAVES

ARCHITRAVES

High above windows and doors, architraves work to add grandeur to any space – reducing miter lines and elevating your look. A great architrave is, above all else, the dressing that’s built to impress.



Stock Code	Dimensions
MFPU5000 (1045933)	1 1/8" x 3 3/4" x 12'
MFPU50002 (1448071)	1 1/8" x 3 3/4" x 8'
MDF/UL	



Stock Code	Dimensions
MFPU5020 (1005107)	1 3/16" x 5 1/4" x 12'
MFPU5020-08 (1448075)	1 3/16" x 5 1/4" x 8'
MDF/UL	

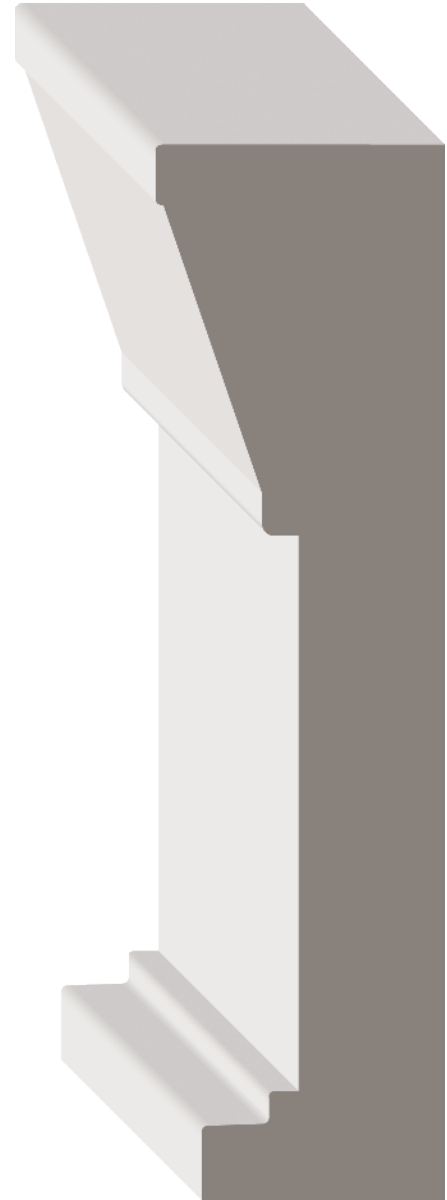

Stock Code	Dimensions
MFPU5015 (1328514)	1 1/2" x 5 1/2" x 12'
MFPU5015-08 (1448073)	1 1/2" x 5 1/2" x 8'
MDF/UL	

BACK BANDS

Back Bands are used in conjunction with casing or baseboard to create a wide variety of trim options for windows and doors.

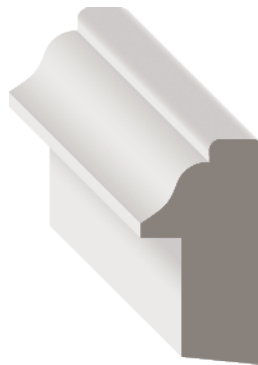

Stock Code
PFP3414-102
(1544829)

Dimensions
 $\frac{3}{4}$ " x $1\frac{1}{4}$ " x 8'6"

PFP3414-16
(1544830)

PRI

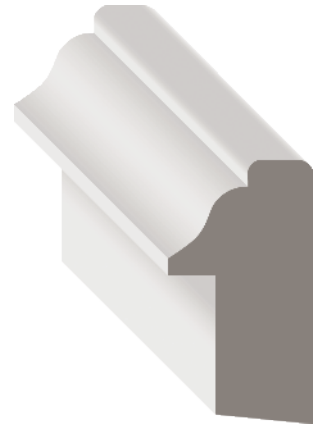

Stock Code
POP2990-08
(1544884)

Dimensions
 $\frac{3}{4}$ " x $1\frac{3}{8}$ " x 8'

POP



Stock Code
PFP1209-102
(1544805)

Dimensions
 $\frac{3}{4}$ " x $1\frac{1}{4}$ " x 8'6"

PFP1209-16
(1544804)

PRI

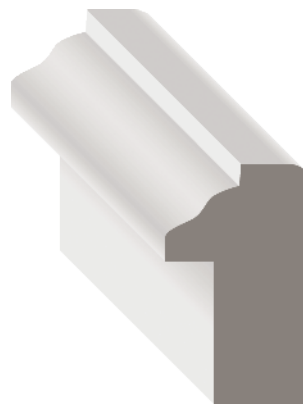

Stock Code
MP2990BK1
(1544557)

Dimensions
 $\frac{3}{4}$ " x $1\frac{1}{4}$ " x 16'

MP2990BK-08
(1544556)

PFJ

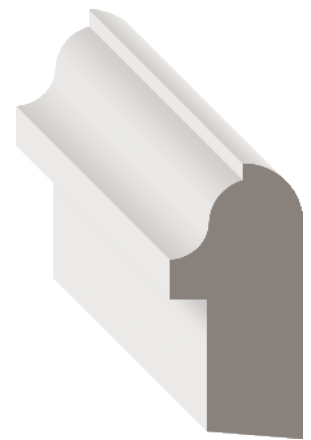

Stock Code
MP2900BK-15
(1544547)

Dimensions
 $\frac{1}{16}$ " x $1\frac{1}{16}$ " x 15'

PFJ

BASEBOARDS

BASEBOARDS

Your look starts here – at the foundation of a room.

A great baseboard complements a casing and creates a smooth transition from the wall to the floor, guiding you seamlessly from room to room.



Stock Code
MP21301
 (1448208)
MP21302
 (1448209)

Dimensions
 $\frac{5}{16}'' \times 3\frac{1}{8}'' \times 16'$
 $\frac{5}{16}'' \times 3\frac{1}{8}'' \times 8'$

PFJ

MSP12112
 (1448340)

Dimensions
 $\frac{5}{16}'' \times 3\frac{1}{8}'' \times 8'$

PIN



Stock Code
V130S
 (1448610)

Dimensions
 $\frac{3}{8}'' \times 3\frac{1}{8}'' \times 8'$

PVC



Stock Code
MM12102
 (1448130)

Dimensions
 $\frac{5}{16}'' \times 3\frac{1}{8}'' \times 8'$

MAH

BASEBOARDS



Stock Code
MP26071
 (1510157)
MP26072
 (1448227)

Dimensions
 $5/16" \times 2^{15}/16" \times 16'$
 $5/16" \times 2^{15}/16" \times 8'$

PFJ



Stock Code
V606S
 (1510771)

Dimensions
 $3/8" \times 2^{15}/16" \times 8'$

PVC



Stock Code
MTEK8622B-12
 (1544754)
MTEK8622B-08
 (1544753)

Dimensions
 $3/8" \times 3^{1}/8" \times 12'$
 $3/8" \times 3^{1}/8" \times 8'$

COM

MFP8622B1
 (1448015)
MFP8622B2
 (1448016)

$3/8" \times 3^{1}/8" \times 12'$
 $3/8" \times 3^{1}/8" \times 8'$

MDF/UL



Stock Code
MM12121
 (1544409)
MM12122
 (1448131)

Dimensions
 $3/8" \times 3" \times 16'$
 $3/8" \times 3" \times 8'$

MAH

MR012121
 (1544590)
MR012122
 (1448279)

$3/8" \times 3" \times 6-16'$
 $3/8" \times 3" \times 8'$

O

MSP12121
 (1448341)
MSP12122
 (1448342)

$5/16" \times 3^{1}/8" \times \text{RL}$
 $5/16" \times 3^{1}/8" \times 8'$

PIN

BASEBOARDS



Stock Code **MTEK8910-08**
(1008260) Dimensions $\frac{3}{8}" \times 3\frac{7}{8}" \times 8'$
MTEK8910-12
(1544760) Dimensions $\frac{3}{8}" \times 3\frac{7}{8}" \times 12'$

COM

MFP89102
(1448037) Dimensions $\frac{3}{8}" \times 3\frac{7}{8}" \times 8'$
MFP89101
(1448036) Dimensions $\frac{3}{8}" \times 3\frac{7}{8}" \times 12'$
MFP8910161
(1544226) Dimensions $\frac{3}{8}" \times 3\frac{7}{8}" \times 16'$

MDF/UL



Stock Code **MFP87062**
(1006251) Dimensions $\frac{3}{8}" \times 3\frac{7}{8}" \times 8'$
MFP87061
(1509942) Dimensions $\frac{3}{8}" \times 3\frac{7}{8}" \times 12'$
MFP8706IN-14
(1039502) Dimensions $\frac{3}{8}" \times 3\frac{7}{8}" \times 14'$

MDF/UL



Stock Code **MFP606-08**
(1509806) Dimensions $\frac{1}{2}" \times 4\frac{1}{8}" \times 8'$
MFP606-14
(1509807) Dimensions $\frac{1}{2}" \times 4\frac{1}{8}" \times 14'$

MDF/UL

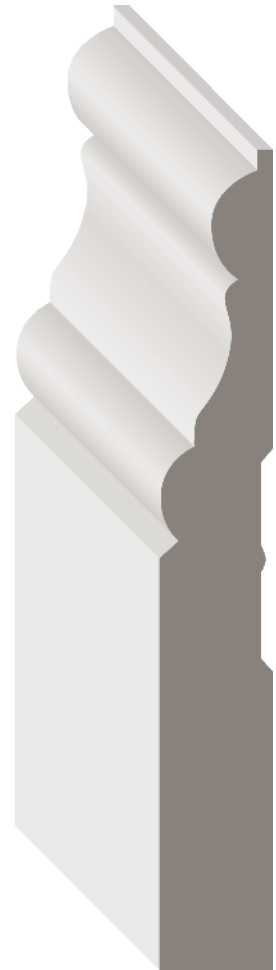

Stock Code **MFPU412**
(1328503) Dimensions $\frac{9}{16}" \times 4\frac{1}{4}" \times 16'$
MFPU4122
(1510002) Dimensions $\frac{9}{16}" \times 4\frac{1}{4}" \times 8'$

MDF/UL

BASEBOARDS



Stock Code
MFJ29111
(1543851)

Dimensions
1/2" x 4 1/8" x 16'

FJR

MP29111
(1544550)

1/2" x 4 1/8" x 16'

PFJ



Stock Code
MRO12151
(1544593)

Dimensions
3/8" x 4 1/8" x RL

0



Stock Code
MFJ29161
(1543854)

Dimensions
3/8" x 4" x 16'

FJR

MP29161
(1448241)

3/8" x 4" x 16'

MP29162
(1448242)

3/8" x 4" x 8'

PFJ

MSP12151
(1448343)

3/8" x 4" x RL

MSP12152
(1448344)

3/8" x 4" x 8'

PIN



Stock Code
MM12152
(1544412)

Dimensions
3/8" x 4 1/8" x 8'

MAH

P251
(1544796)

5/8" x 4 1/8" x RL

PIN

BASEBOARDS

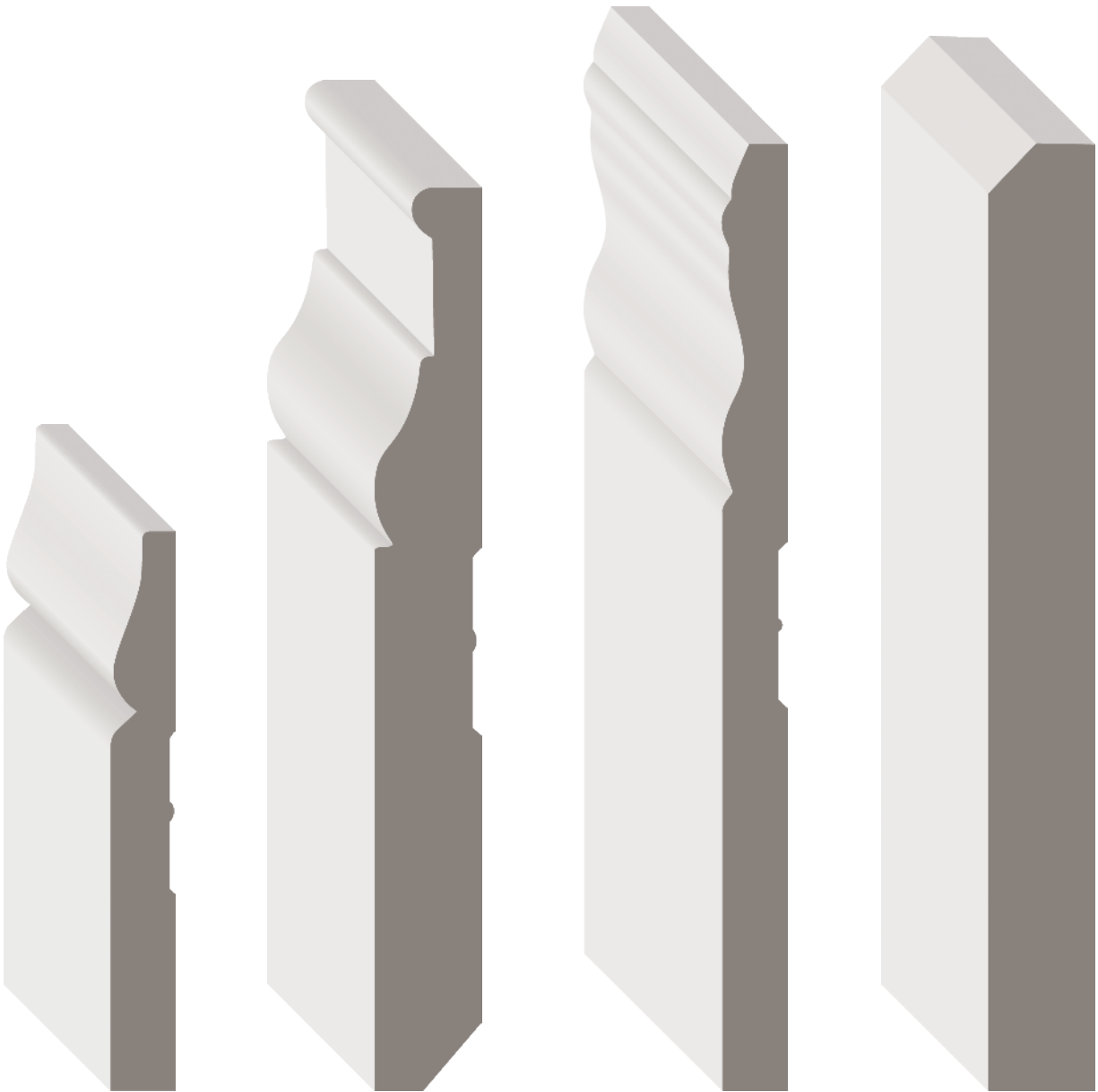

Stock Code
MFP88571
 (1544206)
MFP88572
 (1544207)

Dimensions
 $\frac{3}{8}$ " x $3\frac{1}{4}$ " x 12'
 $\frac{3}{8}$ " x $3\frac{1}{4}$ " x 8'

MDF/UL

Stock Code
MFP82701
 (1447997)
MFP82702
 (1447998)

Dimensions
 $\frac{5}{8}$ " x $5\frac{1}{4}$ " x 12'
 $\frac{5}{8}$ " x $5\frac{1}{4}$ " x 8'

MDF/UL

Stock Code
MFJ25181
 (1543826)

Dimensions
 $\frac{3}{8}$ " x $5\frac{1}{2}$ " x 16'

FJR

MFPU2518
 (1544266)
MFPU25182
 (1544267)

Dimensions
 $\frac{3}{8}$ " x $5\frac{1}{2}$ " x 12'
 $\frac{3}{8}$ " x $5\frac{1}{2}$ " x 8'

MDF/UL

Stock Code
MFP4429-08
 (1509786)
MFP4429-16
 (1039489)

Dimensions
 $\frac{5}{8}$ " x $5\frac{1}{2}$ " x 8'
 $\frac{5}{8}$ " x $5\frac{1}{2}$ " x 16'

MDF/UL

PFP8322-16
 (1637785)

Dimensions
 $\frac{5}{8}$ " x $7\frac{1}{4}$ " x 16'

PRI

BASEBOARDS



Stock Code	Dimensions
MFPU8263 (1341833)	$\frac{3}{16}$ " x 6½" x 16'
MFPU82632 (1448094)	$\frac{3}{16}$ " x 6½" x 8'

MDF/UL

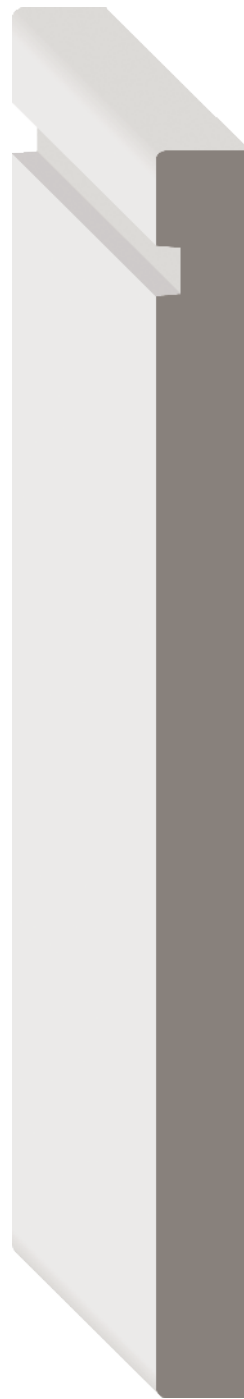

Stock Code	Dimensions
MFPU9291 (1045991)	$\frac{1}{2}$ " x 6½" x 12'
MFPU9291-08 (1039503)	$\frac{1}{2}$ " x 6½" x 8'

MDF/UL

PFP9393-16 (1637787)	$\frac{5}{8}$ " x 6½" x 16'
--------------------------------	-----------------------------

PRI



Stock Code	Dimensions
MFPU9290 (1039350)	$\frac{1}{2}$ " x 5" x 12'
MFPU9290-08 (1039348)	$\frac{1}{2}$ " x 5" x 8'

MDF/UL

PFP9293-16 (1544849)	$\frac{5}{8}$ " x 5" x 16'
--------------------------------	----------------------------

PRI

BASEBOARDS



Stock Code
MTEK3140-08
 (1329023)
MTEK3140-12
 (1329024)

Dimensions
 1/2" x 3 1/4" x 8'
 1/2" x 3 1/4" x 12'

COM



Stock Code
MFP82361
 (1509884)
MFP8236-08
 (1007059)

Dimensions
 3/8" x 3 7/8" x 14'
 3/8" x 3 7/8" x 8'

MDF/UL



Stock Code
PFP8238-16
 (1544836)

Dimensions
 5/8" x 4 1/4" x 16'

PRI



Stock Code
MFP8243
 (1005901)
MFP82432
 (1544310)

Dimensions
 1/2" x 4 1/4" x 12'
 1/2" x 4 1/4" x 8'

MDF/UL

BASEBOARDS



Stock Code
MFP8334-14
 (1005268)
MFP8334
 (1544119)

Dimensions
 $\frac{1}{2}$ " x $5\frac{1}{2}$ " x 14'
 $\frac{1}{2}$ " x $5\frac{1}{2}$ " x 12'

MDF/UL

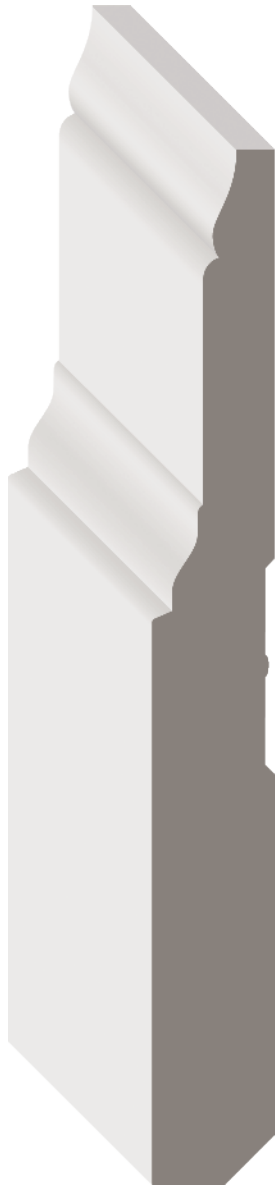

Stock Code
PFP1217-08
 (1544811)
PFP1217-16
 (1544812)

Dimensions
 $\frac{5}{8}$ " x $5\frac{1}{4}$ " x 8'
 $\frac{5}{8}$ " x $5\frac{1}{4}$ " x 16'

PRI



Stock Code
MFP8234161
 (1544068)
MFP82341
 (1447993)
MFP82342
 (1447994)

Dimensions
 $\frac{1}{16}$ " x $5\frac{1}{2}$ " x 16'
 $\frac{1}{16}$ " x $5\frac{1}{2}$ " x 12'
 $\frac{1}{16}$ " x $5\frac{1}{2}$ " x 8'

MDF/UL



Stock Code
MFPU545
 (1341818)
MFPU5452
 (1448085)

Dimensions
 $\frac{3}{16}$ " x 5" x 16'
 $\frac{3}{16}$ " x 5" x 8'

MDF/UL

BASEBOARDS



Stock Code
POP1214-12
(1544865)

Dimensions
5/8" x 4 1/4" x 12'

POP

PFP1214-16
(1544810)

5/8" x 4 1/4" x 16'

PFP1214-08
(1544809)

5/8" x 4 1/4" x 8'

PRI



Stock Code
MFP80952
(1509872)

Dimensions
1/2" x 5 1/4" x 8'

MFP80951
(1006014)

1/2" x 5 1/4" x 12'

MFP8095141
(1544044)

1/2" x 5 1/8" x 14'

MDF/UL



Stock Code
MFP89151
(1448038)

Dimensions
1/2" x 7 1/4" x 12'

MFP89152
(1448039)

1/2" x 7 1/4" x 8'

MDF/UL

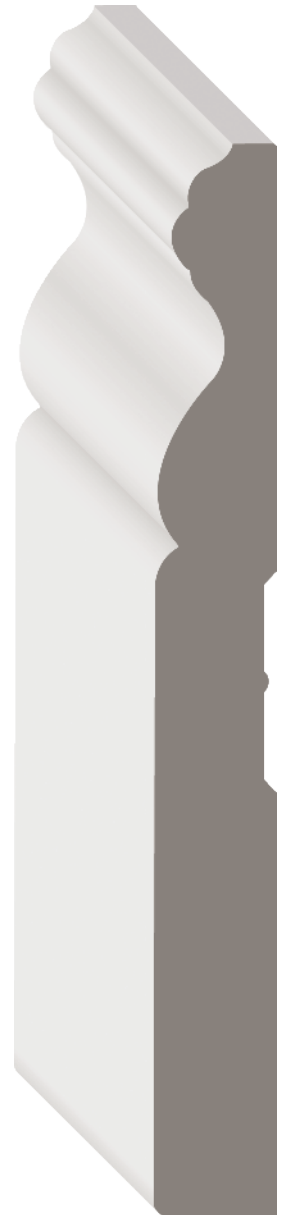

Stock Code
MTEK8955-12
(1007186)

Dimensions
3/16" x 5 1/16" x 12'

MTEK8955-08
(1008273)

3/16" x 5 1/16" x 8'

COM

MFP8955-14
(1509974)

3/16" x 5 1/16" x 14'

MFP89551
(1448042)

3/16" x 5 1/16" x 12'

MFP89552
(1448043)

3/16" x 5 1/16" x 8'

MDF/UL

PFP8955-16
(1544847)

3/16" x 5 1/16" x 16'

PFP8955-08
(1544846)

3/16" x 5 1/16" x 8'

PRI

BASEBOARDS



Stock Code
MFP82351
(1509883)

Dimensions
5/8" x 7 1/4" x 12'

MDF/UL

PFP8235-08 5/8" x 7 1/4" x 8'
 (1544834)

PFP8235-16 5/8" x 7 1/4" x 16'
 (1544835)

PRI



Stock Code
MFP82871
(1544099)

Dimensions
5/8" x 7 1/4" x 12'

MDF/UL



Stock Code
MFP82751
(1544097)

Dimensions
5/8" x 5 1/2" x 12'

MDF/UL



Stock Code
MFP8320-08 1/2" x 4 3/4" x 8'
 (1509905)

MFP8320-12 1/2" x 4 3/4" x 12'
 (1509907)

MDF/UL

BASEBOARDS



Stock Code
PFP8319-16
(1064405)

Dimensions
5/8" x 5 1/2" x 16'

PRI



Stock Code
MFP82371
(1039334)

Dimensions
5/8" x 5 1/2" x 12'

MFP82372
(1509886)

5/8" x 5 1/2" x 8'

MDF/UL

Stock Code
POP12111
(1544862)

Dimensions
1 1/16" x 5 1/2" x 16'

POP

Stock Code
PFP8230-16
(1544833)

Dimensions
2 1/32" x 5 1/4" x 16'

PRI



Stock Code
MFP82391
(1447995)

Dimensions
5/8" x 7 1/4" x 12'

MFP82392
(1447996)

5/8" x 7 1/4" x 8'

MDF/UL

Stock Code
PFP8321-16
(1064411)

Dimensions
5/8" x 7 1/4" x 16'

PFP8239-16
(1544838)

5/8" x 7 1/4" x 16'

PFP8239-08
(1544837)

5/8" x 7 1/4" x 8'

PRI

BASEBOARD CAPS & SHOES

Base caps are added to the top of regular baseboard moulding and flush to the wall to create a finished and more complex architectural moulding. Base shoes are primarily used to trim flooring materials and are often used in combination with a traditional baseboard to conceal variations between the flooring and the base. However, this versatile profile works great to solve numerous trimming needs.

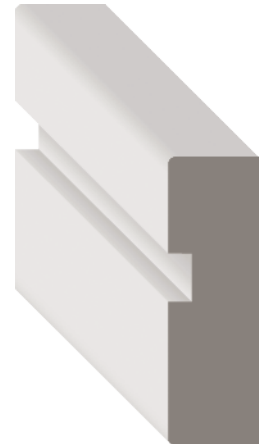

Stock Code	Dimensions
PFP2112-08 (1667879)	$1\frac{5}{32}'' \times 1\frac{1}{2}'' \times 8'$
PFP2112-16 (1544824)	$1\frac{5}{32}'' \times 1\frac{1}{2}'' \times 16'$

PRI



Stock Code	Dimensions
MTEK126-08 (1426891)	$\frac{1}{2}'' \times \frac{3}{4}'' \times 8'$
MTEK126-12 (1426890)	$\frac{1}{2}'' \times \frac{3}{4}'' \times 12'$

COM

MM12342 (1448138)	$\frac{3}{8}'' \times \frac{3}{4}'' \times 8'$
-----------------------------	--

MAH

MR012342 (1328872)	$\frac{1}{2}'' \times \frac{3}{4}'' \times 8'$
------------------------------	--

O

MP21011 (1448197)	$\frac{3}{8}'' \times 1\frac{1}{16}'' \times 16'$
-----------------------------	---

MP21012 (1448198)	$\frac{3}{8}'' \times 1\frac{1}{16}'' \times 8'$
-----------------------------	--

PFJ

MSP1131-08 (1544682)	$\frac{7}{16}'' \times 1\frac{1}{16}'' \times 8'$
--------------------------------	---

MSP1234-12 (1544709)	$\frac{3}{8}'' \times 1\frac{1}{16}'' \times 12'$
--------------------------------	---

MSP12342 (1510305)	$\frac{3}{8}'' \times 1\frac{1}{16}'' \times 8'$
------------------------------	--

PIN



Stock Code	Dimensions
POP1235-08 (1544869)	$\frac{1}{2}'' \times \frac{7}{8}'' \times 8'$

POP

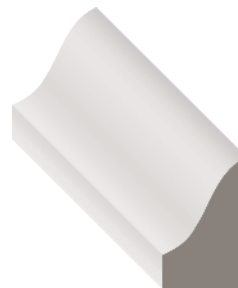

Stock Code	Dimensions
MP2131-08 (1544488)	$\frac{7}{16}'' \times 1\frac{1}{16}'' \times 8'$
MP2131-12 (1544489)	$\frac{7}{16}'' \times 1\frac{1}{16}'' \times 12'$

PFJ

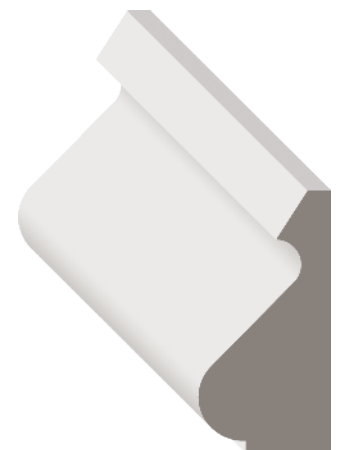

Stock Code	Dimensions
MP2163-08 (1544493)	$\frac{5}{8}'' \times 1\frac{3}{8}'' \times 8'$
MP2163-12 (1544494)	$\frac{5}{8}'' \times 1\frac{3}{8}'' \times 12'$

PFJ

CASINGS

CASINGS

Casings bring a room together – left to right, top to bottom. And like any framing element, the options are endless, from build-ups of multiple pieces to Full wraps. With casings, there's no wrong way, only your way.

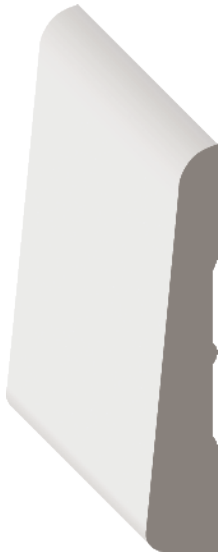

Stock Code
MM12012
(1448126)

Dimensions
 $\frac{3}{8}'' \times 2\frac{1}{8}'' \times 7'$

MAH

MP21101
(1448204)

Dimensions
 $\frac{3}{8}'' \times 2\frac{1}{8}'' \times 14'$

MP21102
(1448205)

Dimensions
 $\frac{3}{8}'' \times 2\frac{1}{8}'' \times 7'$

PFJ

MSP12032
(1448336)

Dimensions
 $\frac{3}{8}'' \times 2\frac{1}{8}'' \times 7'$

PIN



Stock Code
V110S
(1448609)

Dimensions
 $\frac{3}{8}'' \times 2\frac{1}{8}'' \times 7'$

PVC



Stock Code
MM12051
(1544401)
MM12052
(1544402)

Dimensions
 $\frac{7}{16}'' \times 2\frac{1}{4}'' \times \text{RL}$

$\frac{7}{16}'' \times 2\frac{1}{4}'' \times 7'$

MAH



Stock Code
V601S
(1510770)

Dimensions
 $\frac{3}{16}'' \times 2\frac{1}{8}'' \times 7'$

PVC

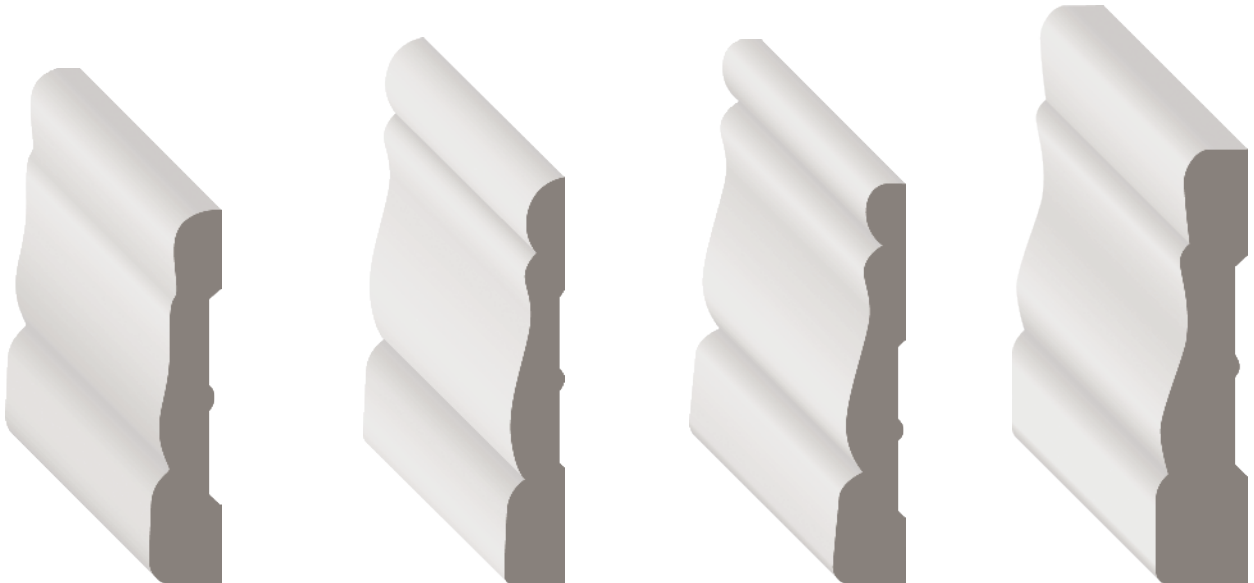

Stock Code
MP26252
(1544535)

Dimensions
 $\frac{3}{8}'' \times 1\frac{15}{16}'' \times 7'$

PFJ

Stock Code
MTEK8621-07
(1045998)

Dimensions
 $\frac{3}{8}'' \times 2\frac{1}{8}'' \times 7'$

COM

MFP8621B1 $\frac{3}{8}'' \times 2\frac{1}{8}'' \times 14'$
(1509929)
MFP8621B2 $\frac{3}{8}'' \times 2\frac{1}{8}'' \times 7'$
(1509930)

MDF/UL

Stock Code
MP26211
(1544529)

Dimensions
 $\frac{3}{8}'' \times 2\frac{1}{16}'' \times 14'$

MP26212
(1448229)

$\frac{3}{8}'' \times 2\frac{1}{16}'' \times 7'$

PFJ

MSP12051 $\frac{3}{8}'' \times 2\frac{1}{16}'' \times 16'$
(1544685)
MSP12052 $\frac{3}{8}'' \times 2\frac{1}{16}'' \times 7'$
(1448337)

PIN

Stock Code
MTEK356-07
(1329027)

Dimensions
 $\frac{7}{16}'' \times 2\frac{1}{4}'' \times 7'$

COM

MFP3561 $\frac{7}{16}'' \times 2\frac{1}{4}'' \times 14'$
(1447959)
MFP3562 $\frac{7}{16}'' \times 2\frac{1}{4}'' \times 7'$
(1447960)

MDF/UL

MR0356 $\frac{7}{16}'' \times 2\frac{1}{16}'' \times 6-16'$
(1626652)
MR03562 $\frac{7}{16}'' \times 2\frac{1}{16}'' \times 7'$
(1328910)

0

CASINGS



Stock Code **MP2356-07**
(1544522)

Dimensions **2¹/₃₂" x 2¹/₄" x 7'**

PFJ

Stock Code **MSP356-07**
(1382742)

Dimensions **2¹/₃₂" x 2¹/₄" x 7'**

PIN



Stock Code **MFP80702**
(1447980)

Dimensions **3/4" x 2³/₄" x 7'**

MDF/UL



Stock Code **MFP80751**
(1544035)

Dimensions **3/4" x 3" x 16'**

MDF/UL



Stock Code **MFPU8063**
(1448090)

Dimensions **1¹/₁₆" x 3¹/₄" x 16'**

Stock Code **MFPU80632**
(1448091)

Dimensions **1¹/₁₆" x 3¹/₄" x 8'**

MDF/UL



Stock Code
MTEK8900-07
(1510345)

Dimensions
 $\frac{3}{16}'' \times 2\frac{3}{4}'' \times 7'$

COM

MFJ290011
(1509689)

$\frac{3}{16}'' \times 2\frac{3}{4}'' \times 14'2''$

MFJ29001D
(1543843)

$\frac{3}{16}'' \times 2\frac{3}{4}'' \times 14'2''$

MFJ29002
(1509688)

$\frac{3}{16}'' \times 2\frac{3}{4}'' \times 7'1''$

MFJ290012
(1543850)

$\frac{3}{16}'' \times 2\frac{3}{4}'' \times 7'1''$

FJR

MM12092
(1448128)

$\frac{3}{16}'' \times 2\frac{3}{4}'' \times 7'$

MAH

Stock Code
MFP8900B1
(1509958)

Dimensions
 $\frac{3}{16}'' \times 2\frac{3}{4}'' \times 14'$

MDF/UL

MFP8900B2
(1509960)

$\frac{3}{16}'' \times 2\frac{3}{4}'' \times 7'1''$

MP29001
(1448238)

$\frac{3}{16}'' \times 2\frac{3}{4}'' \times 14'2''$

MP29002
(1448239)

$\frac{3}{16}'' \times 2\frac{3}{4}'' \times 7'$

PFJ

MSP12091
(1544689)

$\frac{3}{16}'' \times 2\frac{3}{4}'' \times RL$

MSP12092
(1544690)

$\frac{3}{16}'' \times 2\frac{3}{4}'' \times 7'$

PIN

V2900S
(1544921)

$\frac{5}{8}'' \times 2\frac{3}{4}'' \times 7'2''$

PVC

Stock Code
MM12072
(1544404)

Dimensions
 $\frac{3}{16}'' \times 2\frac{7}{16}'' \times 7'$

MAH

MP27102
(1448237)

$\frac{5}{8}'' \times 2\frac{1}{2}'' \times 7'$

PFJ

MSP12072
(1448339)

$1\frac{1}{16}'' \times 2\frac{1}{4}'' \times 7'$

PIN

Stock Code
MR012061
(1544584)

Dimensions
 $\frac{5}{8}'' \times 2\frac{11}{16}'' \times RL$

O

CASINGS



Stock Code Dimensions
POP12101 $\frac{3}{4}" \times 2\frac{3}{4}" \times \text{RL}$
 (1544859)
POP12102 $\frac{3}{4}" \times 2\frac{3}{4}" \times 90"$
 (1544861)

POP

PFP1210-16 $\frac{3}{4}" \times 2\frac{3}{4}" \times 16'$
 (1544807)
PFP1210-102 $\frac{3}{4}" \times 2\frac{3}{4}" \times 8'6"$
 (1544806)

PRI



Stock Code Dimensions
MTEK8954-08 $1\frac{1}{16}" \times 3\frac{1}{2}" \times 8'$
 (1010368)
MTEK8954-12 $1\frac{1}{16}" \times 3\frac{1}{2}" \times 12'$
 (1544762)

COM

MFP89541 $1\frac{1}{16}" \times 3\frac{1}{2}" \times \text{RL}$
 (1448040)
MFP895482 $1\frac{1}{16}" \times 3\frac{1}{2}" \times 8'$
 (1448041)

MDF/UL

PFP8954-16 $1\frac{1}{16}" \times 3\frac{1}{2}" \times 16'$
 (1544845)
PFP8954-102 $1\frac{1}{16}" \times 3\frac{1}{2}" \times 8'6"$
 (1544844)

PRI



Stock Code Dimensions
MFPU411 $1\frac{1}{16}" \times 3" \times 16'$
 (1328502)
MFPU412 $1\frac{1}{16}" \times 3" \times 8'$
 (1509998)

MDF/UL



Stock Code Dimensions
MFPU535 $1\frac{1}{16}" \times 3\frac{1}{2}" \times 16'$
 (1610431)
MFPU5352 $1\frac{1}{16}" \times 3\frac{1}{2}" \times 8'$
 (1448082)

MDF/UL



Stock Code	Dimensions
MFP8037-14 (1543987)	$\frac{3}{4}$ " x $2\frac{3}{4}$ " x 14'1"
MFP80372 (1008857)	$\frac{3}{4}$ " x $2\frac{3}{4}$ " x 7'
MDF/UL	



Stock Code	Dimensions
MFP80391 (1039342)	$\frac{3}{4}$ " x $3\frac{1}{2}$ " x 16'
MFP80392 (1328422)	$\frac{3}{4}$ " x $3\frac{1}{2}$ " x 8'1"
MDF/UL	

PFP1208-16 (1544803)	$\frac{3}{4}$ " x $3\frac{1}{2}$ " x 16'
PFP1208-102 (1510358)	$\frac{3}{4}$ " x $3\frac{1}{2}$ " x 8'6"
PRI	



Stock Code	Dimensions
MFP8345-07 (1509912)	$\frac{5}{8}$ " x $2\frac{3}{4}$ " x 7'
MFP8345-14 (1509915)	$\frac{5}{8}$ " x $2\frac{3}{4}$ " x 14'
MDF/UL	



Stock Code	Dimensions
PFP8345-16 (1645261)	$\frac{3}{4}$ " x $3\frac{1}{2}$ " x 16'
PRI	

CASINGS



Stock Code	Dimensions
MFP80321 (1509841)	$\frac{7}{16}$ " x 2 $\frac{13}{16}$ " x 14'
MFP80322 (1509842)	$\frac{7}{16}$ " x 2 $\frac{13}{16}$ " x 7'

MDF/UL

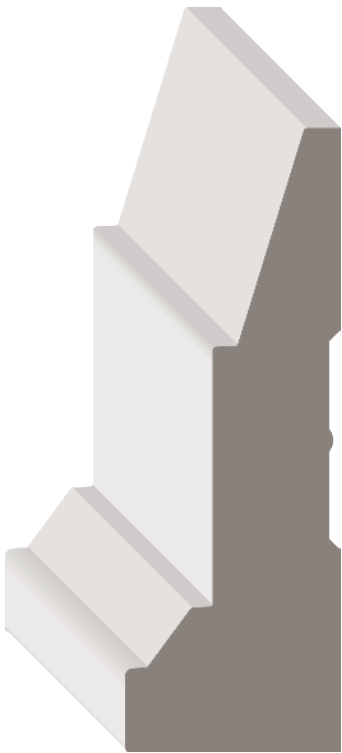

Stock Code	Dimensions
MFP8036BB-08 (1543983)	$1\frac{1}{8}$ " x 3 $\frac{1}{4}$ " x 8'
MFP8036BB-16 (1543985)	$1\frac{1}{8}$ " x 3 $\frac{1}{4}$ " x 16'

MDF/UL



Stock Code	Dimensions
MFP8038CB-16 (1544000)	1" x 3" x 16'

MDF/UL



Stock Code	Dimensions
MFP80311 (1447967)	$1\frac{1}{16}$ " x 3 $\frac{1}{2}$ " x 14'3"
MFP803182 (1447968)	$1\frac{1}{16}$ " x 3 $\frac{1}{2}$ " x 8'

MDF/UL



Stock Code	Dimensions
PFP1204-16 (1544801)	$\frac{3}{4}$ " x 3 $\frac{1}{2}$ " x 16'

PRI

CASINGS



Stock Code
PFP1213-16
(1544808)

Dimensions
3/4" x 2 13/16" x 16'

PRI



Stock Code
MFJ2900CB2
(1543847)

Dimensions
1" x 3" x 7'2"

MFJ2900CB1D
(1543845)

1" x 3" x 14'3"

FJR

MFPU2900CB
(1544271)

1" x 3" x 15'

MFPU2900CB2
(1002482)

1" x 3" x 90'

MDF/UL

MP2900CB-08
(1544548)

1" x 3" x 8'

MP2900CB-12
(1544549)

1" x 3" x 12'

PFJ

PFP2900CB-102
(1544827)

1" x 3" x 8'6"

PFP2900CB-16
(1544828)

1" x 3" x 16'

PRI



Stock Code
MFP8044
(1544010)

Dimensions
1 1/8" x 3 1/2" x 16'

MDF/UL



Stock Code
MFP80871
(1544038)

Dimensions
1 1/8" x 3 1/2" x 14'1"

MFP80872
(1544040)

1 1/8" x 3 1/2" x 8'

MDF/UL

CASINGS

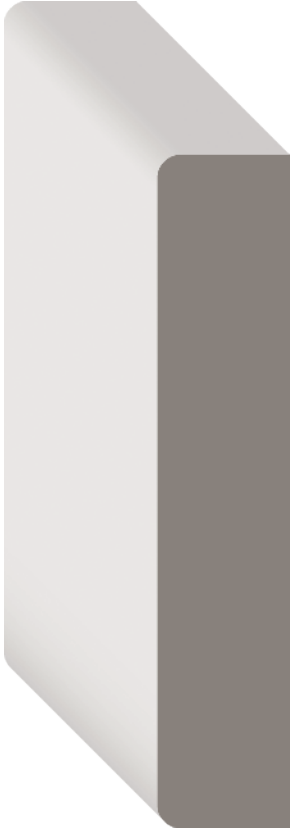

Stock Code	Dimensions
MFP8490-07 (1544148)	$\frac{1}{2}'' \times 2'' \times 7'$
MFP8323-07 (1544114)	$\frac{5}{8}'' \times 2\frac{3}{4}'' \times 7'$
MFP8323-08 (1544115)	$\frac{5}{8}'' \times 2\frac{3}{4}'' \times 8'$
MDF/UL	
<hr/>	
PFP1804-16 (1064431)	$1\frac{1}{16}'' \times 3\frac{1}{2}'' \times 16'$
PRI	



Stock Code	Dimensions
1673692	$\frac{3}{4}'' \times 3\frac{1}{2}'' \times 8'$
COM	
<hr/>	
MFP4494-08 (1039555)	$\frac{3}{4}'' \times 3\frac{1}{2}'' \times 8'$
MFP4494-16 (1509797)	$\frac{3}{4}'' \times 3\frac{1}{2}'' \times 16'$
MDF/UL	

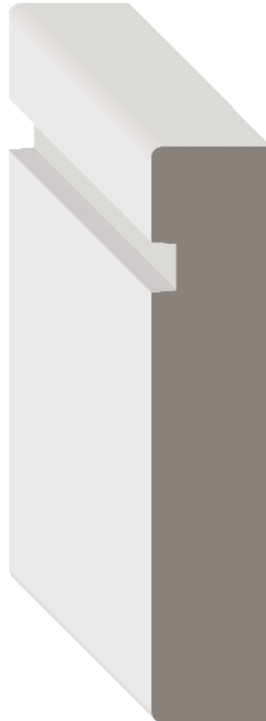

Stock Code	Dimensions
MFPU9090 (1039485)	$\frac{5}{8}'' \times 3'' \times 16'$
MFPU9090-08 (1039349)	$\frac{5}{8}'' \times 3'' \times 8'$
MDF/UL	

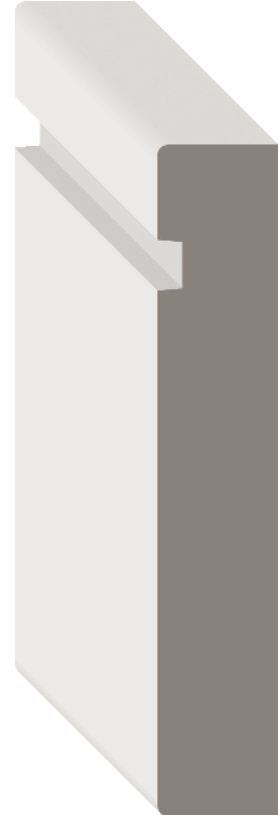

Stock Code	Dimensions
MFPU9091 (1039352)	$\frac{5}{8}'' \times 3\frac{1}{2}'' \times 16'$
MFPU9091-08 (1039482)	$\frac{5}{8}'' \times 3\frac{1}{2}'' \times 8'$
MDF/UL	
<hr/>	
PFP9093-102 (1637786)	$\frac{3}{4}'' \times 3\frac{1}{2}'' \times 8'6''$
PFP9093-16 (1544848)	$\frac{3}{4}'' \times 3\frac{1}{2}'' \times 16'$
PRI	

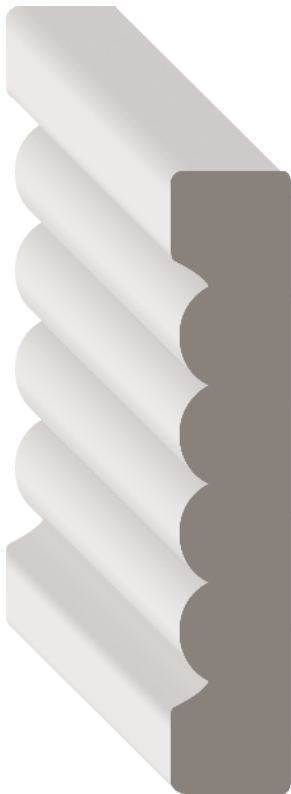

Stock Code
MFP8338-08
(1004722)

Dimensions
 $\frac{5}{8}$ " x $3\frac{3}{8}$ " x 8'

MDF/UL



Stock Code
MFP80651
(1544031)

Dimensions
 $\frac{3}{4}$ " x $3\frac{1}{2}$ " x 16'

MFP806582
(1509868)

MDF/UL



Stock Code
MFP89772
(1509976)

Dimensions
 $\frac{3}{4}$ " x $3\frac{1}{16}$ " x 8'

MDF/UL

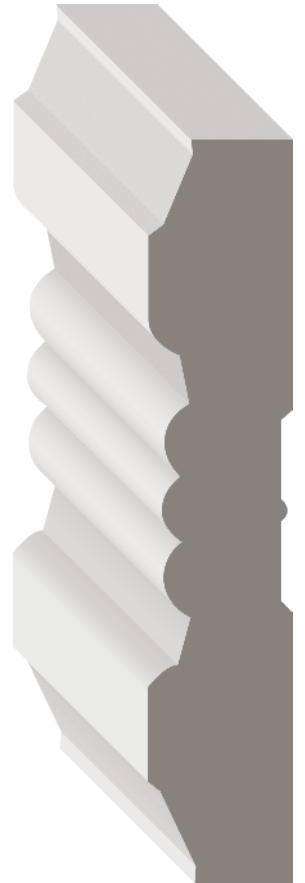

Stock Code
MFP8062B2
(1447978)

Dimensions
 $\frac{3}{4}$ " x $3\frac{7}{8}$ " x 7'

MFP8062B1
(1447977)

MDF/UL

CHAIR RAILS

CHAIR RAILS

The chair rail runs along the wall, parallel with the baseboard. Adding a refined decor to any space, it's the subtle choice that makes a big impact. The chair rail perfectly complements a wainscot design.



Stock Code
MFP83001
(1448003)
MFP83002
(1008285)

Dimensions
5/16" x 1 3/4" x 12'
5/16" x 1 3/4" x 8'

MDF/UL



Stock Code
MSP12601
(1544724)
MSP12602
(1448360)

Dimensions
1 1/16" x 1 3/4" x RL
1 1/16" x 1 3/4" x 8'

PIN

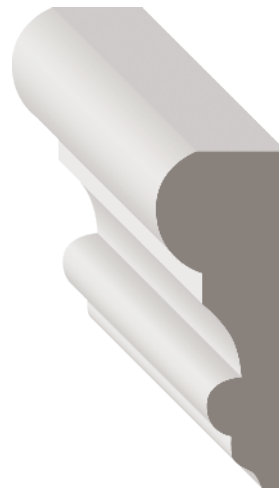

Stock Code
MR012602
(1448289)

Dimensions
5/16" x 1 3/4" x 8'

O



Stock Code
MTEK8390-08
(1544750)

Dimensions
5/8" x 2 1/2" x 8'

COM

MFP83901
(1509921) **5/8" x 2 1/2" x 12'**
MFP83902
(1448006) **5/8" x 2 1/2" x 8'**

MDF/UL

CHAIR RAILS

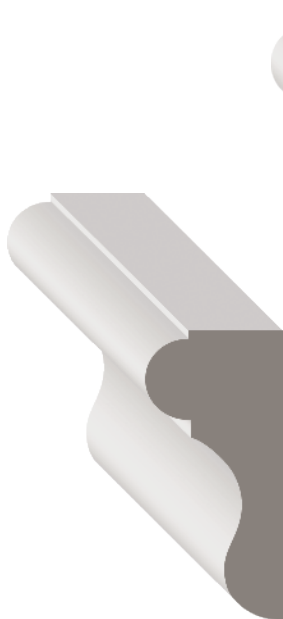

Stock Code

MP466-16
(1544570)

Dimensions
5/8" x 1 1/2" x 16'

MP466-08
(1544569)

5/8" x 1 1/2" x 8'

PFJ



Stock Code

MP26902
(1544538)

Dimensions
1" x 2 3/8" x 8'

PFJ



Stock Code

MP2298-08
(1544520)

Dimensions
5/8" x 2 1/2" x 8'

MP2298-12
(1544521)

5/8" x 2 1/2" x 8'

PFJ



Stock Code

MTEK297-08
(1544738)

Dimensions
1 1/16" x 3" x 8'

COM

CORNER GUARDS

CORNER GUARDS

Corner guards are used to protect the outside edges of the wall from damage and abrasion. Corner guards come in a wide variety of sizes and detailing.

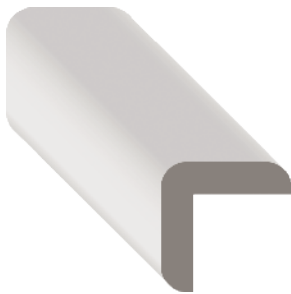

Stock Code
MSP12532
(1448357)

Dimensions
1¹/₁₆" x 1¹/₁₆" x 8'

PIN

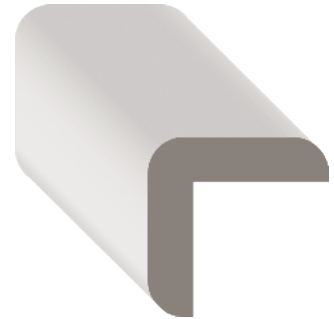

Stock Code
MP21712
(1448212)

Dimensions
1⁵/₁₆" x 1⁵/₁₆" x 8'

PFJ



Stock Code
MP21702
(1448211)

Dimensions
1¹/₁₆" x 1¹/₁₆" x 8'

PFJ



Stock Code
V170S
(1448611)

Dimensions
3/4" x 3/4" x 8'

PVC

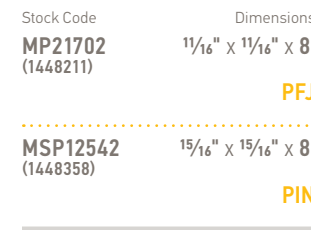

Stock Code
MSP12542
(1448358)

Dimensions
1⁵/₁₆" x 1⁵/₁₆" x 8'

PIN

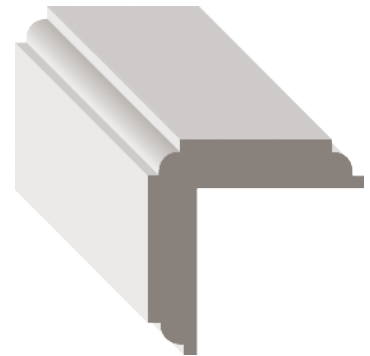

Stock Code
MR012542
(1448287)

Dimensions
1¹/₈" x 1¹/₈" x 8'

O

COVES

Coves are commonly used to soften the transition on inside corners but may be used for a wide range of applications.

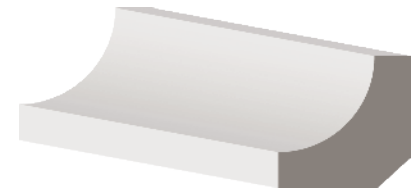

Stock Code **MM12422**
(1448140) Dimensions $1\frac{1}{16}'' \times 1\frac{1}{16}'' \times 8'$

MAH

Stock Code **MR012422**
(1328889) Dimensions $1\frac{1}{16}'' \times 1\frac{1}{16}'' \times 8'$

O

Stock Code **POP3264-08**
(1544886) Dimensions $1\frac{1}{16}'' \times 1\frac{1}{16}'' \times 8'$

POP



Stock Code **MP21052**
(1448201) Dimensions $\frac{1}{2}'' \times \frac{1}{2}'' \times 8'$

PFJ



Stock Code **MR012412**
(1448284) Dimensions $\frac{1}{2}'' \times \frac{1}{2}'' \times 8'$

O

Stock Code **MSP12412**
(1448351) Dimensions $\frac{1}{2}'' \times \frac{1}{2}'' \times 8'$

PIN

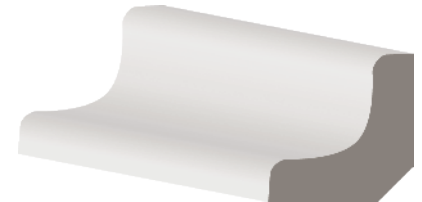

Stock Code **V106S**
(1448608) Dimensions $\frac{3}{4}'' \times \frac{3}{4}'' \times 8'$

PVC

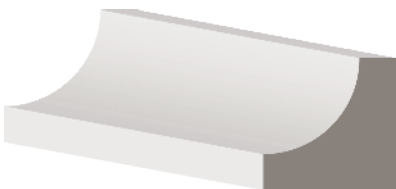

Stock Code **MSP12421**
(1544712) Dimensions $1\frac{1}{16}'' \times 1\frac{1}{16}'' \times 6-16'$

Stock Code **MSP12422**
(1448353) Dimensions $1\frac{1}{16}'' \times 1\frac{1}{16}'' \times 8'$

PIN



Stock Code **MP21061**
(1448202) Dimensions $1\frac{1}{16}'' \times 1\frac{1}{16}'' \times 16'$

Stock Code **MP21062**
(1382343) Dimensions $1\frac{1}{16}'' \times 1\frac{1}{16}'' \times 8'$

PFJ



Stock Code **MP455-08**
(1544568) Dimensions $1\frac{5}{16}'' \times 1\frac{5}{16}'' \times 8'$

PFJ

CROWNS

CROWNS

Cap off your look with the perfect crown. A great crown is the royal wrap-up of all your moulding decisions.

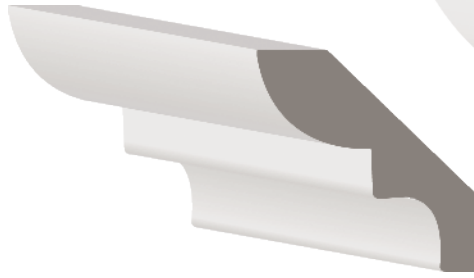

Stock Code
MP2173-08
(1448214)

Dimensions
7/16" x 1 5/8" x 8'

PFJ

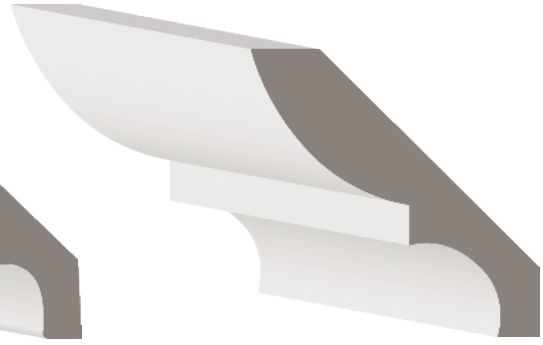

Stock Code
MP21742
(1544501)

Dimensions
7/16" x 2 1/8" x 8'

PFJ



Stock Code
MFPU5212
(1544294)

Dimensions
1 1/16" x 2 1/2" x 8'

MDF/UL

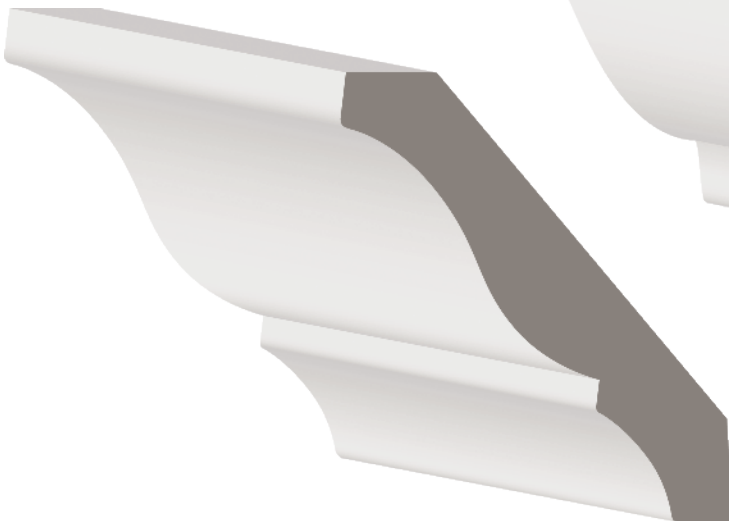

Stock Code
MSP711-08
(1448365)

Dimensions
9/16" x 3 1/16" x 8'

PIN



Stock Code
MP21801
(1448215)

Dimensions
9/16" x 4 1/2" x 16'

PFJ

Stock Code
MSP729-08
(1637783)

Dimensions
9/16" x 4 1/2" x 8'

PIN

CROWN CORNER BLOCKS

Outside and inside corner blocks to match with MFP80571, MFP80572, MFP47 and MFP47-08.



Stock Code	Dimensions
FFPCOC8057 (1543584)	5/8" x 3 5/16"
FFPCOC8058 (1543585)	5/8" x 3 5/16"
FFLCOC47 (1543565)	5/8" x 4 1/4"

MDF/UL

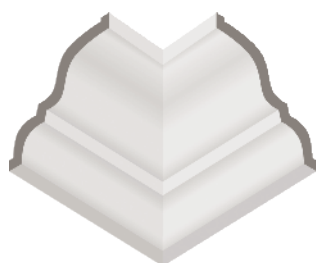

Stock Code	Dimensions
FFPCIC8057 (1447810)	5/8" x 3 1/16"
FFPCIC8058 (1543583)	5/8" x 3 5/16"
FFLCIC47 (1543563)	5/8" x 4 1/4"

MDF/UL

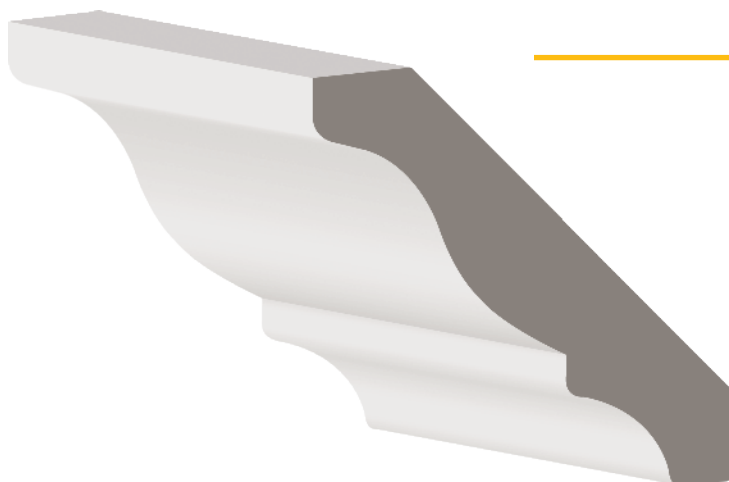

Stock Code	Dimensions
MFP80571 (1447971)	1/2" x 3 1/16" x 12'
MFP80572 (1447973)	1/2" x 3 1/16" x 8'

MDF/UL



Stock Code	Dimensions
MTEK47-08 (1510342)	5/8" x 4 1/4" x 8'

COM

MFP47 (1626166)	5/8" x 4 1/4" x 16'
MFP47-08 (1448066)	5/8" x 4 1/4" x 8'

MDF/UL

PFP1226-16 (1544819)	1 1/16" x 4 1/4" x 16'
--------------------------------	------------------------

PRI

CROWNS



Stock Code	Dimensions
MFP8048B1 (1509856)	$\frac{3}{16}$ " x $4\frac{1}{8}$ " x 12'
MFP8048B2 (1509858)	$\frac{3}{16}$ " x $4\frac{1}{8}$ " x 8'

MDF/UL



Stock Code	Dimensions
MFP85121 (1448008)	$\frac{3}{16}$ " x $5\frac{5}{8}$ " x 12'
MFP85122 (1509928)	$\frac{3}{16}$ " x $5\frac{5}{8}$ " x 8'

MDF/UL

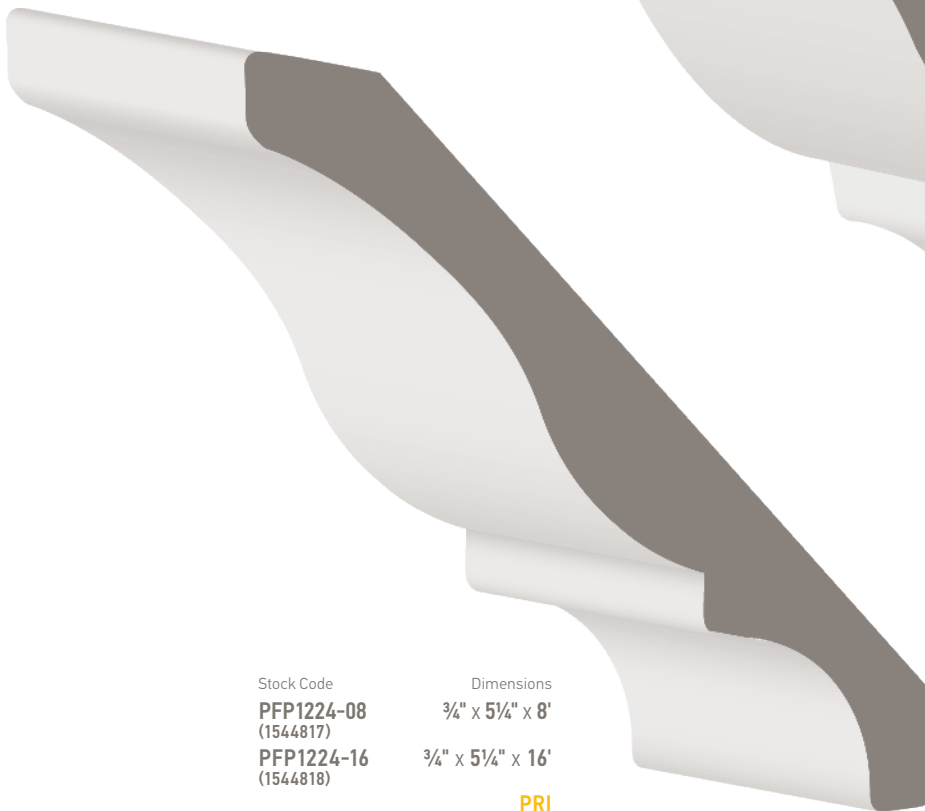

Stock Code	Dimensions
PFP1224-08 (1544817)	$\frac{3}{4}$ " x $5\frac{1}{4}$ " x 8'
PFP1224-16 (1544818)	$\frac{3}{4}$ " x $5\frac{1}{4}$ " x 16'

PRI

CROWNS

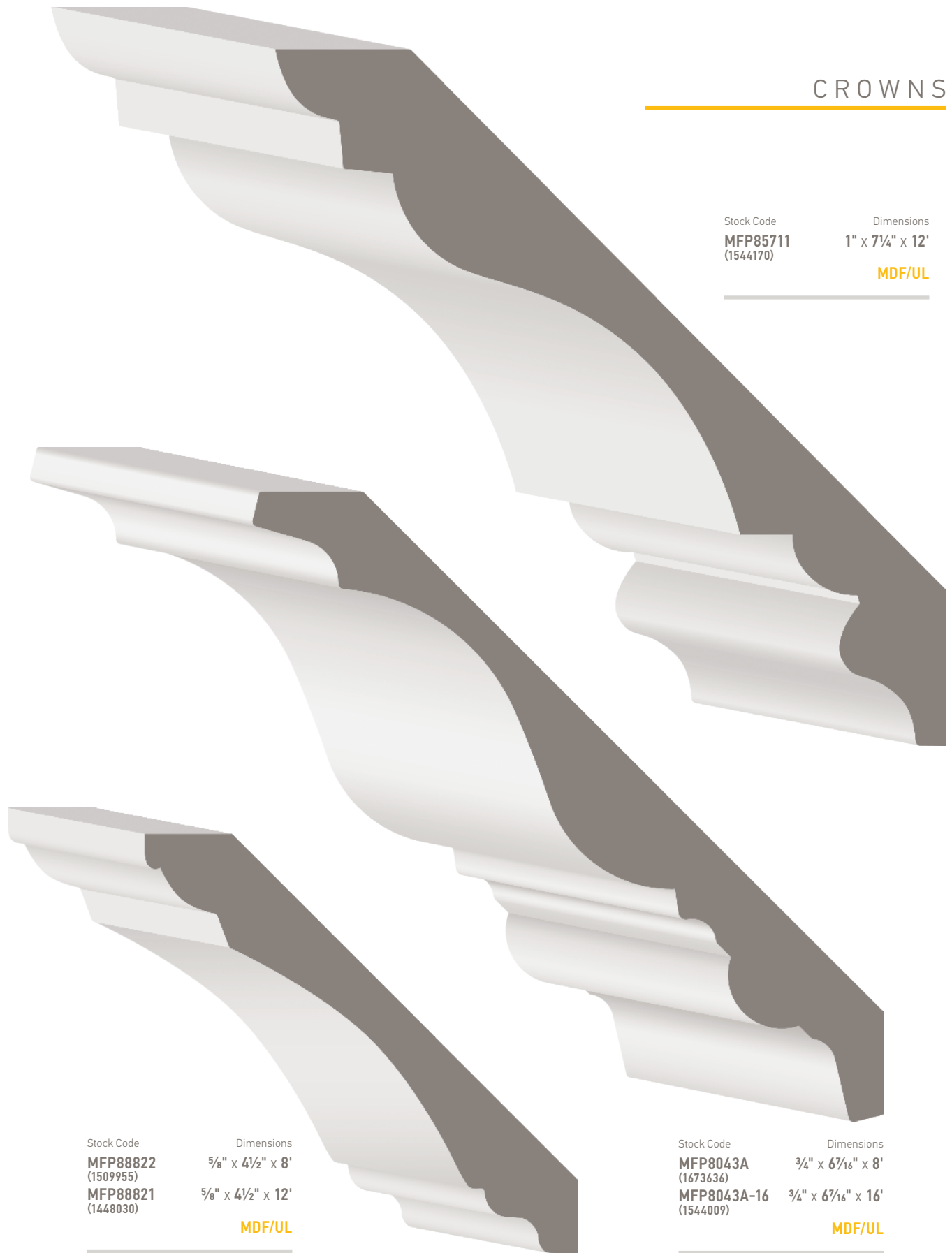

Stock Code
MFP85711
(1544170)

Dimensions
1" x 7¼" x 12'

MDF/UL

Stock Code
MFP88822
(1509955)
MFP88821
(1448030)

Dimensions
5/8" x 4½" x 8'
5/8" x 4½" x 12'

MDF/UL

Stock Code
MFP8043A
(1673636)
MFP8043A-16
(1544009)

Dimensions
¾" x 6⅞" x 8'
¾" x 6⅞" x 16'

MDF/UL

CROWNS



Stock Code
1461282
MFPU41
(1626152)

Dimensions
1³/₁₆" x 6⁵/₁₆" x 8'
1³/₁₆" x 6⁵/₁₆" x 16'

MDF/UL

Stock Code
MFPU43
(1555825)

Dimensions
1" x 6⁵/₁₆" x 16'

MDF/UL

CROWNS



Stock Code
MTEK8058-08
(1544747)

Dimensions
 $\frac{1}{2}'' \times 3\frac{5}{16}'' \times 8'$

COM

MFP80581
(1447975)

$\frac{1}{2}'' \times 3\frac{5}{16}'' \times 12'$

MFP8058-08
(1509864)

$\frac{1}{2}'' \times 3\frac{5}{16}'' \times 8'$

MFP8058-12
(1509865)

$\frac{1}{2}'' \times 3\frac{5}{16}'' \times 12'$

MDF/UL

MR080581
(1544679)

$\frac{3}{16}'' \times 3\frac{5}{16}'' \times \text{RL}$

0

Stock Code
MFP8051S-12
(1544019)

Dimensions
 $\frac{5}{8}'' \times 5\frac{1}{4}'' \times 12'$

MDF/UL

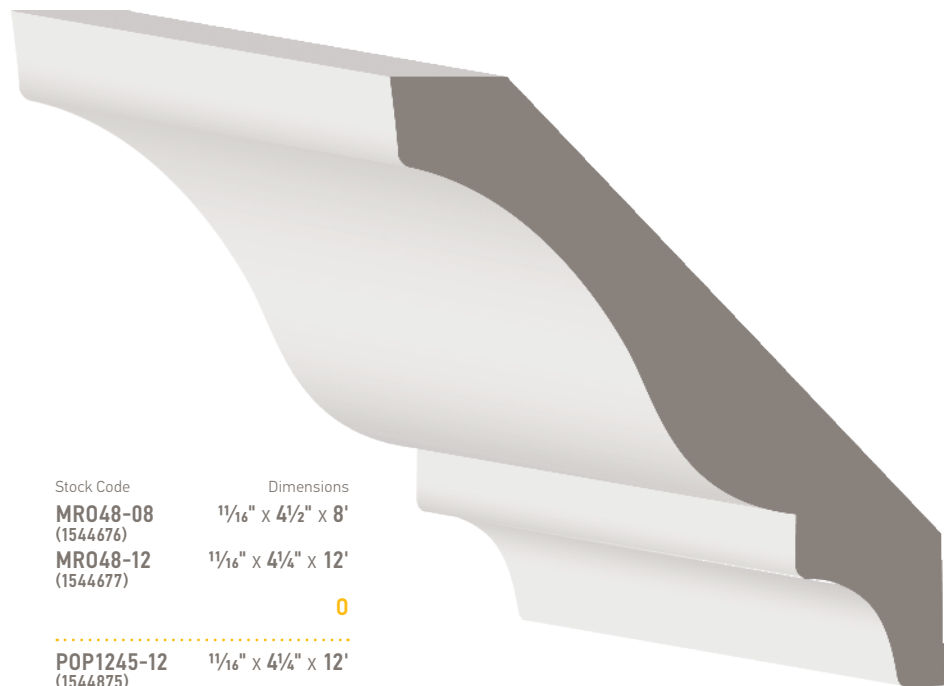

Stock Code
MR048-08
(1544676)

Dimensions
 $1\frac{1}{16}'' \times 4\frac{1}{2}'' \times 8'$

MR048-12
(1544677)

$1\frac{1}{16}'' \times 4\frac{1}{4}'' \times 12'$

0

POP1245-12
(1544875)

$1\frac{1}{16}'' \times 4\frac{1}{4}'' \times 12'$

POP

CROWNS

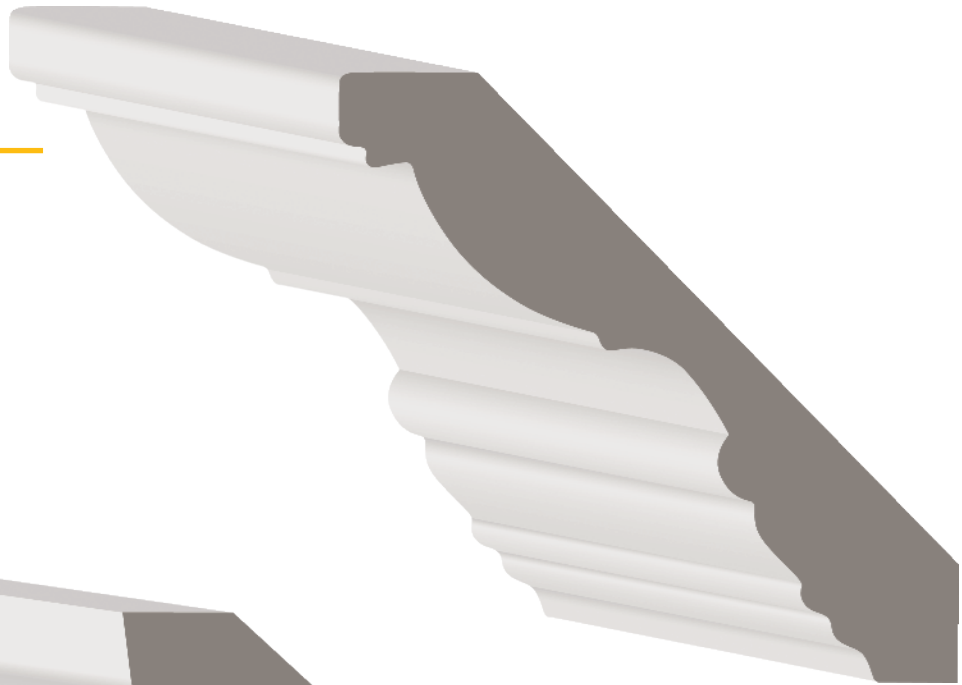

Stock Code
MFPU712
(1448088)
MFPU7122
(1448089)

Dimensions
1 1/16" x 4 1/2" x 16'
1 1/16" x 4 1/2" x 8'

MDF/UL



Stock Code
MFP8696-12
(1010755)

Dimensions
1 1/16" x 5 7/8" x 12'

MDF/UL



Stock Code
MFPU60
(1544300)

Dimensions
1 1/16" x 5 1/2" x 16'

MDF/UL

CROWNS



Stock Code	Dimensions
MFPU901 (1544317)	1$\frac{3}{16}$" x 6$\frac{3}{4}$" x 12'
MFPU901-08 (1007269)	1$\frac{3}{16}$" x 6$\frac{3}{4}$" x 8'

MDF/UL

Stock Code	Dimensions
MFPU900 (1328541)	1$\frac{3}{16}$" x 5$\frac{1}{4}$" x 12'
MFPU900-08 (1328542)	1$\frac{3}{16}$" x 5$\frac{1}{4}$" x 8'

MDF/UL

DOOR STOPS

DOOR STOPS

The door stop mouldings are attached to the door jamb on both sides and at the top. It is where the door comes to a rest when it is closed, stopping the door from moving any further, and covering the gap that would otherwise appear between the door and the jambs.

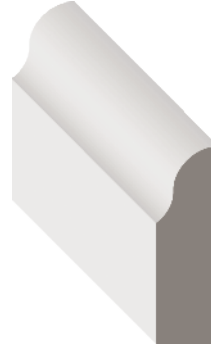

Stock Code
MM12232
(1448134)

Dimensions
 $\frac{3}{8}$ " x $1\frac{1}{4}$ " x 7'

MAH



Stock Code
MTEK8662-07
(1544755)

Dimensions
 $\frac{3}{8}$ " x $1\frac{3}{8}$ " x 7'

COM

MSP12232
(1448346)

$\frac{5}{16}$ " x 1" x 7'

PIN

MFP8662B2
(1509936)

$\frac{3}{8}$ " x $1\frac{3}{8}$ " x 7'

MFP83032
(1544106)

$\frac{3}{8}$ " x $1\frac{5}{8}$ " x 7'

MDF/UL

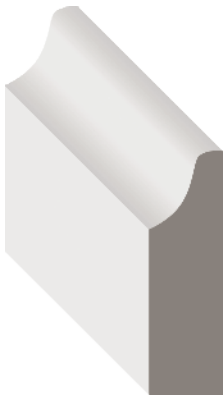

Stock Code
MFP86642
(1544192)

Dimensions
 $\frac{7}{16}$ " x $1\frac{1}{4}$ " x 7'

MDF/UL

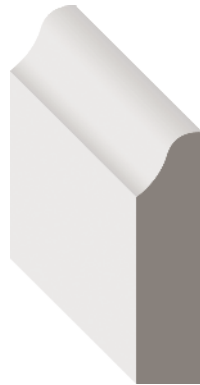

Stock Code
MFP8116-14
(1544052)

Dimensions
 $\frac{1}{2}$ " x $1\frac{1}{8}$ " x 14'

MDF/UL

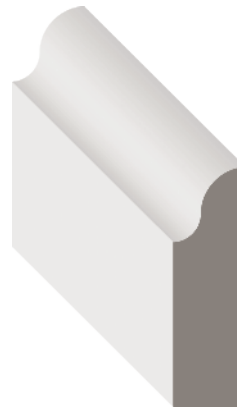

Stock Code
MFJ22732
(1509674)

Dimensions
 $\frac{3}{8}$ " x $1\frac{3}{8}$ " x 7'

FJR



Stock Code
MP2114-08
(1448206)

Dimensions
 $\frac{1}{2}$ " x $1\frac{1}{4}$ " x 8'

PFJ

MP22731
(1510154)

$\frac{3}{8}$ " x $1\frac{3}{8}$ " x 14'

MP22732
(1510155)

$\frac{3}{8}$ " x $1\frac{3}{8}$ " x 7'

PFJ

DOOR STOPS



Stock Code
MFJ26912
(1543837)

Dimensions
3/8" x 7/8" x 7'1"

FJR



Stock Code
MP2381T-12
(1544524)

Dimensions
3/8" x 1" x 12'

PFJ



Stock Code
MR012222
(1448281)

Dimensions
3/8" x 1 3/16" x 7'

O

POP1222-07
(1544867)

Dimensions
3/8" x 1 1/4" x 7'

POP

PFP1222-16
(1544813)

Dimensions
3/8" x 1 1/4" x 16'

PFP1222-98
(1544814)

Dimensions
3/8" x 1 1/4" x 98"

PRI

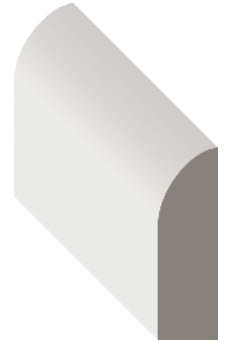

Stock Code
MP20701
(1544466)

Dimensions
5/16" x 1" x 14'

MP20702
(1448194)

Dimensions
5/16" x 1" x 7'

PFJ

MSP12212
(1448345)

Dimensions
5/16" x 1" x 7'

PIN



Stock Code
MFP8319-14
(1509904)

Dimensions
3/8" x 1 1/4" x 14'

MFP8319-07
(1509903)

Dimensions
3/8" x 1 1/4" x 7'

MDF/UL



Stock Code
MFP8119-08
(1667878)

Dimensions
3/8" x 1 1/4" x 8'

MFP8119-14
(1544053)

Dimensions
3/8" x 1 1/4" x 14'

MDF/UL



Stock Code
V70S
(1448615)

Dimensions
3/8" x 1 1/4" x 7'

PVC



Stock Code
MFP1223-14
(1543865)

Dimensions
7/16" x 1 1/4" x 14'

MFP1223-98
(1663061)

Dimensions
7/16" x 1 1/4" x 98"

MDF/UL



Stock Code
PFP8240-16
(1544839)

Dimensions
1/2" x 1 1/2" x 16'

PRI

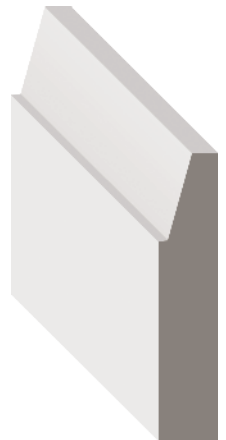

Stock Code
PFP1223-16
(1544815)

Dimensions
5/16" x 1 1/2" x 16'

PFP1223-98
(1544816)

Dimensions
5/16" x 1 1/2"

PRI

FLAT STOCK

FLAT STOCK

Finish boards come in S4S (Surfaced 4 sides). They are available in Square edge or E2E (Eased 2 Edge). They are used for a multitude of purposes including shelving, window ledges, base, casing, etc.

Stock Code	(Nominal)	Actual Dimensions	Species	Desc.
1329018	(1" x 4" x 12')	11/16" x 3-1/2" x 8' (1 pc)	COM	S4S
1675313	(1" x 4" x 12')	11/16" x 3-1/2" x 12' (1 pc)	COM	S4S
1673771	(1" x 6" x 8')	11/16" x 5-1/2" x 8' (1 pc)	COM	S4S
1675317	(1" x 6" x 12')	3/4" x 5-1/2" x 12' (1 pc)	COM	S4S
MTEK103-08 (1544734)	(1" x 3" x 8')	11/16" x 2-1/2" x 8' (1 pc)	COM	S4S
MFJ102D-08 (1543797)	(1" x 2" x 8')	3/4" x 1-1/2" x 8' (1 pc)	FJR	S4S
MFJ103D-08 (1509637)	(1" x 3" x 8')	3/4" x 2-1/2" x 8' (1 pc)	FJR	S4S
MFJ104D-08 (1509638)	(1" x 4" x 8')	3/4" x 3-1/2" x 8' (1 pc)	FJR	S4S
MFJ105D-08 (1509639)	(1" x 5" x 8')	3/4" x 4-1/2" x 8' (1 pc)	FJR	S4S
MFJ106-16 (1543802)	(1" x 6" x 16')	11/16" x 5-1/2" x 16' (1 pc)	FJR	S4S
MFJ106D-08 (1509640)	(1" x 6" x 8')	3/4" x 5-1/2" x 8' (1 pc)	FJR	S4S
MFJ108-16 (1543805)	(1" x 8" x 16')	11/16" x 7-1/4" x 16' (1 pc)	FJR	S4S
MFJ108D-08 (1509641)	(1" x 8" x 8')	3/4" x 7-1/4" x 8' (1 pc)	FJR	S4S
MFJ108D-16 (1543807)	(1" x 8" x 16')	3/4" x 7-1/4" x 16' (1 pc)	FJR	S4S
MFJ112D-08 (1543808)	(1" x 12" x 8')	3/4" x 11-1/4" x 8' (1 pc)	FJR	S4S
LKPI1/204-06 (1509498)	(1/2" x 4" x 6')	1/2" x 3-1/2" x 6' (1 pc)	KPIN	S4S
LKPI1/204-08 (1509499)	(1/2" x 4" x 8')	1/2" x 3-1/2" x 8' (1 pc)	KPIN	S4S
LKPI1/206-08 (1509501)	(1/2" x 6" x 8')	1/2" x 5-1/2" x 8' (1 pc)	KPIN	S4S
LKP102-06 (1509503)	(1" x 2" x 6')	3/4" x 1-1/2" x 6' (1 pc)	KPIN	S4S
LKP102-08 (1509504)	(1" x 2" x 8')	3/4" x 1-1/2" x 8' (1 pc)	KPIN	S4S
LKP103-08 (1509506)	(1" x 3" x 8')	3/4" x 2-1/2" x 8' (1 pc)	KPIN	S4S
LKP104-06 (1509508)	(1" x 4" x 6')	3/4" x 3-1/2" x 6' (1 pc)	KPIN	S4S
LKP104-08 (1509509)	(1" x 4" x 8')	3/4" x 3-1/2" x 8' (1 pc)	KPIN	S4S
LKP105-04 (1447854)	(1" x 5" x 4')	3/4" x 4-1/2" x 4' (1 pc)	KPIN	S4S
LKP105-06 (1447855)	(1" x 5" x 6')	3/4" x 4-1/2" x 6' (1 pc)	KPIN	S4S
LKP105-08 (1509512)	(1" x 5" x 8')	3/4" x 4-1/2" x 8' (1 pc)	KPIN	S4S
LKP106-04 (1447856)	(1" x 6" x 4')	3/4" x 5-1/2" x 4' (1 pc)	KPIN	S4S
LKP106-06 (1447857)	(1" x 6" x 6')	3/4" x 5-1/2" x 6' (1 pc)	KPIN	S4S
LKP106-08 (1447858)	(1" x 6" x 8')	3/4" x 5-1/2" x 8' (1 pc)	KPIN	S4S
LKP106-10 (1509516)	(1" x 6" x 10')	3/4" x 5 1/2" x 10' (1 pc)	KPIN	S4S
LKP108-06 (1509518)	(1" x 8" x 6')	3/4" x 7-1/4" x 6' (1 pc)	KPIN	S4S
LKP108-08 (1447860)	(1" x 8" x 8')	3/4" x 7-1/4" x 8' (1 pc)	KPIN	S4S
LKP108-10 (1447861)	(1" x 8" x 10')	3/4" x 7-1/4" x 10' (1 pc)	KPIN	S4S
LKP110-04 (1674178)	(1" x 10" x 4')	3/4" x 9-1/4" x 4' (1 pc)	KPIN	S4S
LKP110-08 (1447863)	(1" x 10" x 8')	3/4" x 9-1/4" x 8' (1 pc)	KPIN	S4S
LKP112-04 (1674177)	(1" x 12" x 4')	3/4" x 11-1/4" x 4' (1 pc)	KPIN	S4S
LKP112-06 (1447864)	(1" x 12" x 6')	3/4" x 11-1/4" x 6' (1 pc)	KPIN	S4S
LKP112-08 (1543653)	(1" x 12" x 8')	3/4" x 11-1/4" x 8' (1 pc)	KPIN	S4S

Stock Code	(Nominal)	Actual Dimensions	Species	Desc.
LKP202-06 (1509523)	(2" x 2" x 6')	1-1/2" x 1-1/2" x 6' (1 pc)	KPIN	S4S
LKP202-08 (1509524)	(2" x 2" x 8')	1-1/2" x 1-1/2" x 8' (1 pc)	KPIN	S4S
LKP204-08 (1509526)	(2" x 4" x 8')	1-1/2" x 3-1/2" x 8' (1 pc)	KPIN	S4S
LMP102-04 (1328078)	(1" x 2" x 4')	3/4" x 1-1/2" x 4' (1 pc)	MAP/BIR	S4S
LMP102-06 (1328079)	(1" x 2" x 6')	3/4" x 1-1/2" x 6' (1 pc)	MAP/BIR	S4S
LMP102-08 (1447868)	(1" x 2" x 8')	3/4" x 1-1/2" x 8' (1 pc)	MAP/BIR	S4S
LMP103-04 (1328082)	(1" x 3" x 4')	3/4" x 2-1/2" x 4' (1 pc)	MAP/BIR	S4S
LMP103-06 (1328083)	(1" x 3" x 6')	3/4" x 2-1/2" x 6' (1 pc)	MAP/BIR	S4S
LMP103-08 (1447871)	(1" x 3" x 8')	3/4" x 2-1/2" x 8' (1 pc)	MAP/BIR	S4S
LMP104-04 (1328086)	(1" x 4" x 4')	3/4" x 3-1/2" x 4' (1 pc)	MAP/BIR	S4S
LMP104-06 (1328087)	(1" x 4" x 6')	3/4" x 3-1/2" x 6' (1 pc)	MAP/BIR	S4S
LMP104-08 (1447874)	(1" x 4" x 8')	3/4" x 3-1/2" x 8' (1 pc)	MAP/BIR	S4S
LMP106-04 (1328091)	(1" x 6" x 4')	3/4" x 5-1/2" x 4' (1 pc)	MAP/BIR	S4S
LMP106-06 (1328092)	(1" x 6" x 6')	3/4" x 5-1/2" x 6' (1 pc)	MAP/BIR	S4S
LMP106-08 (1447877)	(1" x 6" x 8')	3/4" x 5-1/2" x 8' (1 pc)	MAP/BIR	S4S
LMP108-04 (1328095)	(1" x 8" x 4')	3/4" x 7-1/4" x 4' (1 pc)	MAP/BIR	S4S
LMP108-06 (1328096)	(1" x 8" x 6')	3/4" x 7-1/4" x 6' (1 pc)	MAP/BIR	S4S
LMP108-08 (1447879)	(1" x 8" x 8')	3/4" x 7-1/4" x 8' (1 pc)	MAP/BIR	S4S
1679425	(1" x 4" x 16')	11/16" x 3-1/2" x 16'	MDF/UL	S4S
MFPL104-08 (1005832)	(1" x 4" x 8')	11/16" x 3-1/2" x 8' (1 pc)	MDF/UL	S4S
MFP1408-VP (1328256)	(1" x 4" x 8')	1/2" x 3-1/2" x 8' (1VP-80LF)	MDF/UL	E2E
MFP1802-08 (1543876)	(1" x 2" x 8')	18mm x 1-1/2" x 8' (1 pc)	MDF/UL	S4S E2E
MFP1802-12 (1543877)	(1" x 2" x 12')	18mm x 1-1/2" x 12' (1 pc)	MDF/UL	S4S E2E
MFP1803-08 (1543878)	(1" x 3" x 8')	18mm x 2-1/2" x 8' (1 pc)	MDF/UL	S4S E2E
MFP1803-12 (1543879)	(1" x 3" x 12')	18mm x 2-1/2" x 12' (1 pc)	MDF/UL	S4S E2E
MFP1804-08 (1543880)	(1" x 4" x 8')	18mm x 3-1/2" x 8' (1 pc)	MDF/UL	S4S E2E
MFP1804-12 (1543881)	(1" x 4" x 12')	18mm x 3-1/2" x 12' (1 pc)	MDF/UL	S4S E2E
MFP1805-08 (1543882)	(1" x 5" x 8')	18mm x 4-9/16" x 8' (1 pc)	MDF/UL	S4S E2E
MFP1805-12 (1543883)	(1" x 5" x 8')	11/16" x 4-9/16" x 12' (1 pc)	MDF/UL	S4S E2E
MFP1806-08 (1543884)	(1" x 6" x 8')	18mm x 5-1/2" x 8' (1 pc)	MDF/UL	S4S E2E
MFP1806-12 (1543885)	(1" x 6" x 12')	18mm x 5-1/2" x 12' (1 pc)	MDF/UL	S4S E2E
MFP1808-08 (1543886)	(1" x 8" x 8')	18mm x 7-1/4" x 8' (1 pc)	MDF/UL	S4S E2E
MFP1808-12 (1543887)	(1" x 8" x 12')	18mm x 7-1/4" x 12' (1 pc)	MDF/UL	S4S E2E
MFP1X2-08 (1447950)	(1" x 2" x 8')	9/16" x 1-1/2" x 8' (8 pcs)	MDF/UL	E2E
MFP1X2-12 (1009631)	(1" x 2" x 12')	9/16" x 1-1/2" x 12' (8 pcs)	MDF/UL	E2E
MFP1X3-08 (1447951)	(1" x 3" x 8')	9/16" x 2-1/2" x 8' (4 pcs)	MDF/UL	E2E
MFP1X3-12 (1003824)	(1" x 3" x 12')	9/16" x 2-1/2" x 12' (4 pcs)	MDF/UL	E2E
MFP1X4-08 (1447952)	(1" x 4" x 8')	9/16" x 3-1/2" x 8' (4 pcs)	MDF/UL	E2E
MFP1X4-12 (1009825)	(1" x 4" x 12')	9/16" x 3-1/2" x 12' (4 pcs)	MDF/UL	E2E
MFP1X5-08 (1447953)	(1" x 5" x 8')	9/16" x 4-1/2" x 8' (4 pcs)	MDF/UL	E2E
MFP1X5-12 (1509760)	(1" x 5" x 12')	9/16" x 4-1/2" x 12' (4 pcs)	MDF/UL	E2E
MFP1X6-08 (1447954)	(1" x 6" x 8')	9/16" x 5-1/2" x 8' (4 pcs)	MDF/UL	E2E
MFP1X6-12 (1509764)	(1" x 6" x 12')	9/16" x 5-1/2" x 12' (4 pcs)	MDF/UL	E2E
MFP1X6-16 (1006289)	(1" x 6" x 16')	9/16" x 5-1/2" x 16' (4 pcs)	MDF/UL	E2E
MFP1X8-08 (1447955)	(1" x 8" x 8')	9/16" x 7-1/4" x 8' (2 pcs)	MDF/UL	E2E
MFP1X8-12 (1509768)	(1" x 8" x 12')	9/16" x 7-1/4" x 12' (2 pcs)	MDF/UL	E2E
MFP1X12-08 (1010156)	(1" x 12" x 8')	5/8" x 11-1/4" x 8'	MDF/UL	E2E
MFPL106-08 (1002084)	(1" x 6" x 8')	11/16" x 5-1/2" x 8'	MDF/UL	E2E
LRO1/2X3-3 (1328157)	(1" x 3" x 3')	1/4" x 2-1/2" x 3'	0	S4S
LRO1/2X4-3 (1328158)	(1" x 4" x 3')	1/4" x 3-1/2" x 3'	0	S4S

Stock Code	(Nominal)	Actual Dimensions	Species	Desc.
LR01/2X6-3 (1328159)	(1" x 6" x 3')	1/2" x 5-1/2" x 3'	0	S4S
LR01/4X4-4 (1328163)	(1" x 4" x 4')	1/4" x 3-1/2" x 4'	0	S4S
LR01/4X6-4 (1328164)	(1" x 6" x 4')	1/4" x 5-1/2" x 4'	0	S4S
LR0102-03 (1672820)	(1" x 2" x 3')	3/4" x 1-1/2" x 3' (1 pc)	0	S4S
LR0102-04 (1328166)	(1" x 2" x 4')	3/4" x 1-1/2" x 4' (1 pc)	0	S4S
LR0102-06 (1328167)	(1" x 2" x 6')	3/4" x 1-1/2" x 6' (1 pc)	0	S4S
LR0102-08 (1447905)	(1" x 2" x 8')	3/4" x 1-1/2" x 8' (1 pc)	0	S4S
LR0102-10 (1328169)	(1" x 2" x 10')	3/4" x 1-1/2" x 10' (1 pc)	0	S4S
LR0103-04 (1328171)	(1" x 3" x 4')	3/4" x 2-1/2" x 4'	0	S4S
LR0103-06 (1328172)	(1" x 3" x 6')	3/4" x 2-1/2" x 6' (1 pc)	0	S4S
LR0103-08 (1008341)	(1" x 3" x 8')	3/4" x 2-1/2" x 8' (1 pc)	0	S4S
LR0103-10 (1328174)	(1" x 3" x 10')	3/4" x 2-1/2" x 10' (1 pc)	0	S4S
LR0104-04 (1328176)	(1" x 4" x 4')	3/4" x 3-1/2" x 4' (1 pc)	0	S4S
LR0104-06 (1328177)	(1" x 4" x 6')	3/4" x 3-1/2" x 6' (1 pc)	0	S4S
LR0104-08 (1447912)	(1" x 4" x 8')	3/4" x 3-1/2" x 8' (1 pc)	0	S4S
LR0104-10 (1010613)	(1" x 4" x 10')	3/4" x 3-1/2" x 10' (1 pc)	0	S4S
LR0105-04 (1328181)	(1" x 5" x 4')	3/4" x 4-1/2" x 4' (1 pc)	0	S4S
LR0105-06 (1328182)	(1" x 5" x 6')	3/4" x 4-1/2" x 6' (1 pc)	0	S4S
LR0105-08 (1447915)	(1" x 5" x 8')	3/4" x 4-1/2" x 8' (1 pc)	0	S4S
LR0105-10 (1328184)	(1" x 5" x 10')	3/4" x 4-1/2" x 10' (1 pc)	0	S4S
LR0106-04 (1328186)	(1" x 6" x 4')	3/4" x 5-1/2" x 4' (1 pc)	0	S4S
LR0106-06 (1328187)	(1" x 6" x 6')	3/4" x 5-1/2" x 6' (1 pc)	0	S4S
LR0106-08 (1447919)	(1" x 6" x 8')	3/4" x 5-1/2" x 8' (1 pc)	0	S4S
LR0106-10 (1328189)	(1" x 6" x 10')	3/4" x 5-1/2" x 10' (1 pc)	0	S4S
LR0108-04 (1328191)	(1" x 8" x 4')	3/4" x 7-1/4" x 4' (1 pc)	0	S4S
LR0108-06 (1328192)	(1" x 8" x 6')	3/4" x 7-1/4" x 6' (1 pc)	0	S4S
LR0108-08 (1447923)	(1" x 8" x 8')	3/4" x 7-1/4" x 8' (1 pc)	0	S4S
LR0108-10 (1328194)	(1" x 8" x 10')	3/4" x 7-1/4" x 10' (1 pc)	0	S4S
LR0112-04 (1328197)	(1" x 12" x 4')	3/4" x 11-1/4" x 4'	0	S4S
LR0112-06 (1328198)	(1" x 12" x 6')	3/4" x 11-1/4" x 6'	0	S4S
MP22282 (1544512)	(1" x 1" x 8')	13/32" x 21/32" x 8'	PFJ	S4S
MPIX12-08 (1544459)	(1" x 12" x 8')	23/32" x 11-1/4" x 8'	PFJ	S4S
MPIX22 (1544460)	(1" x 2" x 8')	11/16" x 1-1/2" x 8' (1 pc)	PFJ	S4S
MPIX32 (1544461)	(1" x 3" x 8')	11/16" x 2-1/2" x 8' (1 pc)	PFJ	S4S
MPIX42 (1448184)	(1" x 4" x 8')	11/16" x 3-1/2" x 8' (1 pc)	PFJ	S4S
MPIX52 (1448186)	(1" x 5" x 8')	11/16" x 4-1/2" x 8' (1 pc)	PFJ	S4S
MPIX62 (1448188)	(1" x 6" x 8')	11/16" x 5-1/2" x 8' (1 pc)	PFJ	S4S
MPIX82 (1448190)	(1" x 8" x 8')	11/16" x 7-1/4" x 8' (1 pc)	PFJ	S4S
LSP102-04 (1509618)	(1" x 2" x 4')	3/4" x 1-1/2" x 4' (1 pc)	PIN	S4S
LSP102-06 (1447924)	(1" x 2" x 6')	3/4" x 1-1/2" x 6' (1 pc)	PIN	S4S
LSP102-08 (1447925)	(1" x 2" x 8')	3/4" x 1-1/2" x 8' (1 pc)	PIN	S4S
LSP103-03 (1543778)	(1" x 3" x 3')	3/4" x 2-1/2" x 3' (1 pc)	PIN	S4S
LSP103-04 (1509621)	(1" x 3" x 4')	3/4" x 2-1/2" x 4' (1 pc)	PIN	S4S
LSP103-06 (1509622)	(1" x 3" x 6')	3/4" x 2-1/2" x 6' (1 pc)	PIN	S4S
LSP103-08 (1447926)	(1" x 3" x 8')	3/4" x 2-1/2" x 8' (1 pc)	PIN	S4S
LSP104-06 (1447927)	(1" x 4" x 6')	3/4" x 3-1/2" x 6' (1 pc)	PIN	S4S
LSP104-08 (1447928)	(1" x 4" x 8')	3/4" x 3-1/2" x 8' (1 pc)	PIN	S4S
LSP105-06 (1447929)	(1" x 5" x 6')	3/4" x 4-1/2" x 6' (1 pc)	PIN	S4S
LSP105-08 (1509628)	(1" x 5" x 8')	3/4" x 4-1/2" x 8' (1 pc)	PIN	S4S
LSP106-04 (1509629)	(1" x 6" x 4')	3/4" x 5-1/2" x 4' (1 pc)	PIN	S4S

Stock Code	(Nominal)	Actual Dimensions	Species	Desc.
LSP106-06 (1509630)	(1" x 6" x 6')	3/4" x 5-1/2" x 6' (1 pc)	PIN	S4S
LSP106-08 (1447932)	(1" x 6" x 8')	3/4" x 5-1/2" x 8' (1 pc)	PIN	S4S
LSP108-08 (1447934)	(1" x 8" x 8')	3/4" x 7-1/4" x 8' (1 pc)	PIN	S4S
LSP110-06 (1543795)	(1" x 10" x 6')	3/4" x 9-1/4" x 6' (1 pc)	PIN	S4S
LSP110-08 (1543796)	(1" x 10" x 8')	3/4" x 9-1/4" x 8' (1 pc)	PIN	S4S
MSP12282 (1510302)	(1" x 1" x 8')	1/2" x 3/4" x 8' (1 pc)	PIN	S4S
LP1/2X2-3 (1328100)	(1" x 2" x 3')	1/2" x 1-1/2" x 3'	POP	S4S
LP1/2X2-4 (1509543)	(1" x 2" x 4')	1/2" x 1-1/2" x 4'	POP	S4S
LP1/2X3-3 (1328101)	(1" x 3" x 3')	1/2" x 2-1/2" x 3'	POP	S4S
LP1/2X3-4 (1509545)	(1" x 3" x 4')	1/2" x 2-1/2" x 4'	POP	S4S
LP1/2X4-3 (1328102)	(1" x 4" x 3')	1/2" x 3-1/2" x 3'	POP	S4S
LP1/2X4-4 (1509547)	(1" x 4" x 4')	1/2" x 3-1/2" x 4'	POP	S4S
LP1/2X6-3 (1328103)	(1" x 6" x 3')	1/2" x 5-1/2" x 3'	POP	S4S
LP1/2X6-4 (1509549)	(1" x 6" x 4')	1/2" x 5-1/2" x 4'	POP	S4S
LP1/4X2-4 (1328104)	(1" x 2" x 4')	1/4" x 1-1/2" x 4'	POP	S4S
LP1/4X3-4 (1328105)	(1" x 3" x 4')	1/4" x 2-1/2" x 4'	POP	S4S
LP1/4X4-4 (1328106)	(1" x 4" x 4')	1/4" x 3-1/2" x 4'	POP	S4S
LP1/4X6-4 (1328107)	(1" x 6" x 4')	1/4" x 5-1/2" x 4'	POP	S4S
LP1/4X8-4 (1543698)	(1" x 8" x 4')	1/4" x 7-1/4" x 4'	POP	S4S
LP102-03 (1543699)	(1" x 2" x 3')	3/4" x 1-1/2" x 3' (1 pc)	POP	S4S
LP102-04 (1328108)	(1" x 2" x 4')	3/4" x 1-1/2" x 4' (1 pc)	POP	S4S
LP102-06 (1328109)	(1" x 2" x 6')	3/4" x 1-1/2" x 6' (1 pc)	POP	S4S
LP102-10 (1002101)	(1" x 2" x 10')	3/4" x 1-1/2" x 10'	POP	S4S
LP103-04 (1328111)	(1" x 3" x 4')	3/4" x 2-1/2" x 4'	POP	S4S
LP103-06 (1328112)	(1" x 3" x 6')	3/4" x 2-1/2" x 6' (1 pc)	POP	S4S
LP103-08 (1509565)	(1" x 3" x 8')	3/4" x 2-1/2" x 8' (1 pc)	POP	S4S
LP104-03 (1543711)	(1" x 4" x 3')	3/4" x 3-1/2" x 3' (1 pc)	POP	S4S
LP104-04 (1675260)	(1" x 4" x 4')	3/4" x 3-1/2" x 4' (1 pc)	POP	S4S
LP104-06 (1328115)	(1" x 4" x 6')	3/4" x 3-1/2" x 6' (1 pc)	POP	S4S
LP104-08 (1447892)	(1" x 4" x 8')	3/4" x 3-1/2" x 8' (1 pc)	POP	S4S
LP104-10 (1007508)	(1" x 4" x 10')	3/4" x 3-1/2" x 10'	POP	S4S
LP105-04 (1328117)	(1" x 5" x 4')	3/4" x 4-1/2" x 4' (1 pc)	POP	S4S
LP105-06 (1328118)	(1" x 5" x 6')	3/4" x 4-1/2" x 6' (1 pc)	POP	S4S
LP105-08 (1509571)	(1" x 5" x 8')	3/4" x 4-1/2" x 8' (1 pc)	POP	S4S
LP105-10 (1543720)	(1" x 5" x 10')	3/4" x 4-1/2" x 10'	POP	S4S
LP106-04 (1328120)	(1" x 6" x 4')	3/4" x 5-1/2" x 4' (1 pc)	POP	S4S
LP106-06 (1328121)	(1" x 6" x 6')	3/4" x 5-1/2" x 6' (1 pc)	POP	S4S
LP106-08 (1509574)	(1" x 6" x 8')	3/4" x 5-1/2" x 8' (1 pc)	POP	S4S
LP106-10 (1006388)	(1" x 6" x 10')	3/4" x 5-1/2" x 10'	POP	S4S
LP108-04 (1328123)	(1" x 8" x 4')	3/4" x 7-1/4" x 4' (1 pc)	POP	S4S
LP108-06 (1328124)	(1" x 8" x 6')	3/4" x 7-1/4" x 6' (1 pc)	POP	S4S
LP108-08 (1447895)	(1" x 8" x 8')	3/4" x 7-1/4" x 8' (1 pc)	POP	S4S
LP108-10 (1005973)	(1" x 8" x 10')	3/4" x 7-1/4" x 10'	POP	S4S
LP112-04 (1010779)	(1" x 12" x 4')	3/4" x 11-1/4" x 4'	POP	S4S
LP112-06 (1328128)	(1" x 12" x 6')	3/4" x 11-1/4" x 6'	POP	S4S
1677110	(1" x 3" x 16')	3/4" x 2-1/2" x 16'	PRI	S4S
1484401	(1" x 5" x 16')	3/4" x 4-1/2" x 16'	PRI	S4S
1677142	(1" x 5" x 16')	3/4" x 4-1/2" x 16'	PRI	S4S
1472867	(1" x 6" x 16')	3/4" x 5-1/2" x 16'	PRI	S4S
1472901	(1" x 8" x 16')	3/4" x 7-1/4" x 16'	PRI	S4S

JAMBS

JAMBS

The top and two sides of a door or window frame that contact the door or sash: top jamb and side jambs.



Stock Code	Thickness	Width	Length	Species
MTEK8223-07 (1544749)	5/8"	4-9/16"	84"	COM
MFJ22272 (1543817)	5/8"	6-5/8"	84"	FJR
MFJ22522 (1509669)	9/16"	4-9/16"	84"	FJR
MFJ22582 (1447946)	11/16"	4-5/8"	84"	FJR
MM12752 (1544434)	11/16"	4-9/16"	7'	MAH
MFP81092 (1544051)	3/4"	4-5/8"	84"	MDF/UL
MFP8223T2 (1544064)	5/8"	4-5/8"	84"	MDF/UL
MFP82232 (1509880)	5/8"	4-9/16"	7'	MDF/UL
MFP82272 (1544065)	5/8"	6-5/8"	7'	MDF/UL
MP22272 (1544510)	5/8"	6-5/8"	84"	PFJ
MP22522 (1510149)	9/16"	4-9/16"	84"	PFJ
MP22582 (1544515)	11/16"	4-5/8"	7'	PFJ
PFP2258JD-98 (1677346)	11/16"	4-5/8"	97 11/16"	PRI

BRICK MOULDS

A Brick Mould is mainly used as exterior casing around doors. The most common size is 2"; however, 1-1/2" and 1-1/4" sizes are available. Brick Moulds can also be used in place of a crown and as a transition under window sills.

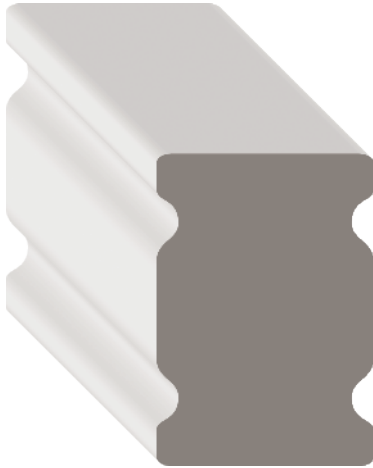

Stock Code **MP558-07**
(1544572) Dimensions **1 1/8" x 1 5/8" x 7'**

PFJ



Stock Code **MFJ25351**
(1543827) Dimensions **1 1/4" x 2" x 16'**
MFJ25352 **1 1/4" x 2" x 8'**
(1509675)

FJR

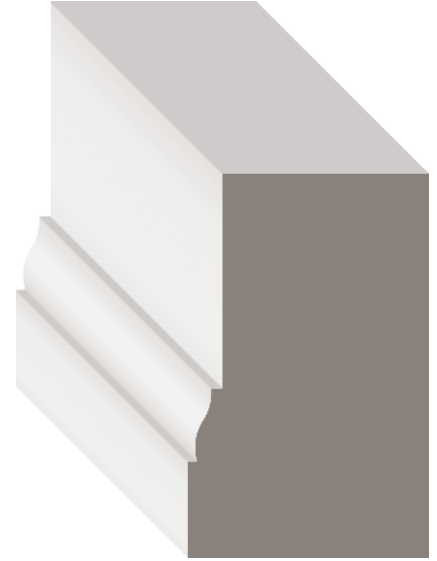

Stock Code **1316205** Dimensions **1 1/4" x 2" x 8'**
PVC

BURLAP

Moulding to hide seams or other blemishes to create seamless transition from one panel or board to another.



Stock Code **MSP12252**
(1448347) Dimensions **1/4" x 1 3/16" x 8'**

PIN



Stock Code **MFJ21661**
(1543811) Dimensions **1/4" x 1 3/16" x 16'**

FJR



Stock Code **MM12262**
(1544416) Dimensions **5/16" x 1 1/2" x 8'**

MAH

MP21662 **1/4" x 1 3/16" x 8'**
(1448210)

PFJ

MP21672 **1/4" x 1 1/16" x 8'**
(1544496)

PFJ

MISCELLANEOUS

BASE CORNERS

A base corner is a radius corner that is used on rounded outside drywall corners. They are designed to match the corresponding profile that was used for the baseboard. When used, no outside miters are necessary.



Stock Code **FFPBIC**
(1447809) Dimensions $\frac{7}{8}" \times \frac{7}{8}" \times 9"$

MDF/UL

Stock Code **FFSPBOC**
(1447818) Dimensions $\frac{3}{4}" \times \frac{3}{4}" \times 9"$

PIN

CORNER BLOCK

A raised decorative wood design used at the intersection of two materials, forming a decorative border. Sometimes corner blocks are used on flush doors for a custom look.

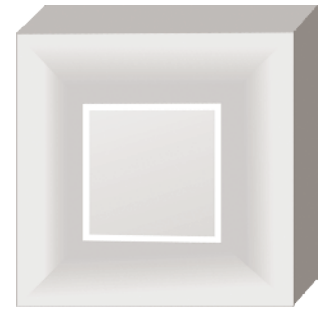

Stock Code **FFP300V**
(1509386) Dimensions $3" \times 3" \times \frac{7}{8}"$

MDF/UL

HANDRAILS

Hand rails provide safety and support.

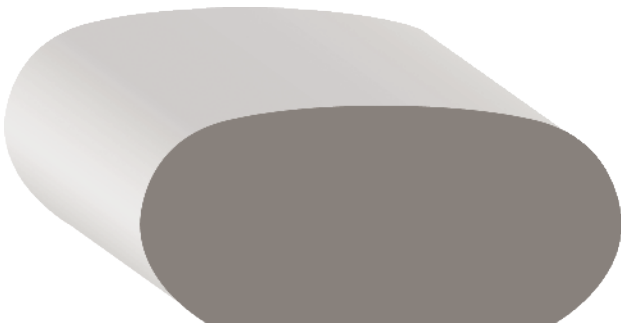

Stock Code **MFJ2196161**
(1543814) Dimensions $1\frac{3}{16}" \times 2\frac{1}{8}" \times 16'$

Stock Code **MFJ2196141**
(1543813) Dimensions $1\frac{3}{16}" \times 2\frac{1}{8}" \times 14'$

Stock Code **MFJ21961**
(1543812) Dimensions $1\frac{3}{16}" \times 2\frac{1}{8}" \times 12'$

Stock Code **MFJ21962**
(1509664) Dimensions $1\frac{3}{16}" \times 2\frac{1}{8}" \times 8'$

FJR

Stock Code **MM12631**
(1544433) Dimensions $\frac{7}{8}" \times 2\frac{1}{2}" \times \text{RL}$

MAH

Stock Code **MP21961**
(1448219) Dimensions $1\frac{3}{16}" \times 2\frac{1}{8}" \times 12'$

PFJ

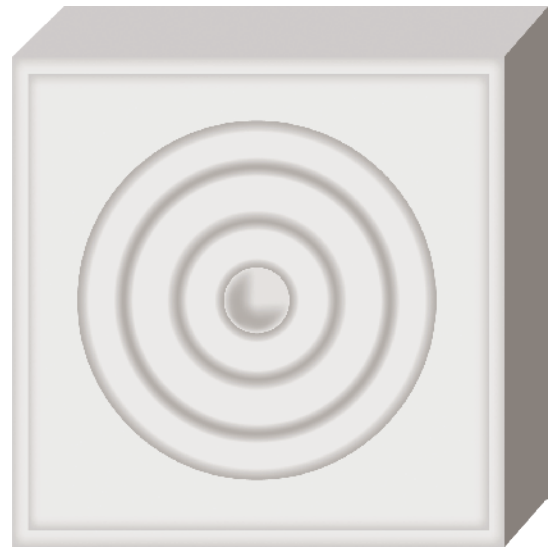

Stock Code **FFP250**
(1447801) Dimensions $2\frac{1}{2}" \times 2\frac{1}{2}" \times \frac{3}{4}"$

Stock Code **FFP300**
(1509384) Dimensions $3" \times 3" \times \frac{3}{4}"$

MDF/UL

Stock Code **FFO300**
(1543568) Dimensions $3" \times 3" \times \frac{7}{8}"$

O

Stock Code **FFSP300**
(1447816) Dimensions $3" \times 3" \times \frac{3}{4}"$

PIN

MISCELLANEOUS

LATTICE

A thin strip of flat moulding commonly used to hide seams and edges.

Stock Code	Dimensions
MP24102 (1510156)	$\frac{1}{4}$ " x $1\frac{1}{16}$ " x 8'
MP446-08 (1544566)	$\frac{1}{4}$ " x $1\frac{1}{16}$ " x 8'

PFJ

MSP12272 (1510301)	$\frac{1}{4}$ " x $1\frac{5}{8}$ " x 8'
------------------------------	---

PIN

V15S (1544918)	$\frac{1}{4}$ " x $1\frac{1}{2}$ " x 8'
--------------------------	---

PVC



DECORATIVE MOULDING

A thin strip of flat moulding commonly used to hide seams and edges.



Stock Code	Dimensions
MP434D-08 (1544565)	$\frac{3}{16}$ " x $\frac{1}{2}$ " x 8'

PFJ

TONGUE & GROOVE PANELING

Panels used to decorate or cover a wall, fitted together edge to edge using a slot and ridge on the opposite edge.



Stock Code	Dimensions
MKP823B-32 (1510071)	$\frac{5}{16}$ " x $3\frac{3}{16}$ " x 32"
MKP823B-48 (1328666)	$\frac{5}{16}$ " x $3\frac{3}{16}$ " x 48"
MKP823B-96 (1328667)	$\frac{5}{16}$ " x $3\frac{3}{16}$ " x 8'

KPIN



Stock Code	Dimensions
MKP823P-96 (1448123)	$\frac{5}{16}$ " x $3\frac{3}{16}$ " x 8'

KPIN



Stock Code	Dimensions
MKP823V-96 (1328668)	$\frac{5}{16}$ " x $3\frac{3}{16}$ " x 8'

KPIN

MKC823-96 (1328657)	$\frac{5}{16}$ " x $3\frac{3}{16}$ " x 8'
-------------------------------	---

MKC

MISCELLANEOUS

PANEL MOULDS

The use of panel moulding can be an effective and inexpensive way to frame wall paneling, paper or fabric, and add interest to walls.

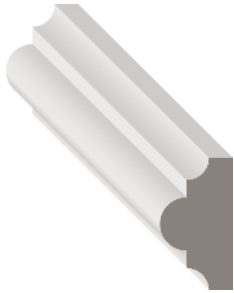

Stock Code
MR012952
(1544614)

Dimensions
3/8" x 1 1/16" x 8'

O



Stock Code
MR012802
(1544609)

Dimensions
5/16" x 1 5/8" x 8'

O

PLY CAP

Used to finish the top edge of a plywood wall treatment. It may also be used as one component of a larger chair rail profile.

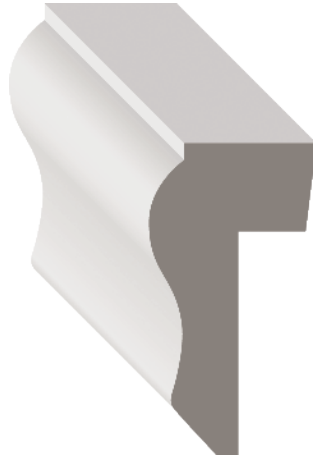

Stock Code
MR012562
(1448288)

Dimensions
3/4" x 1 1/2" x 8'

O

MP1258-08
(1448166)

Dimensions
7/8" x 1 5/8" x 8'

PFJ

MSP12562
(1510312)

Dimensions
9/16" x 1 1/8" x 8'

PIN

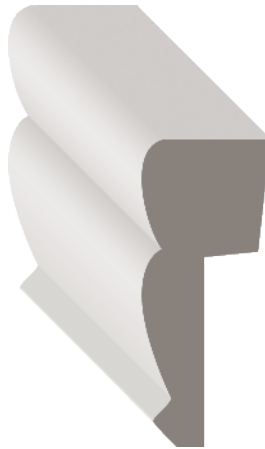

Stock Code
MSP1219-08
(1544697)

Dimensions
1 1/16" x 1 5/8" x 8'

PIN

PLINTH BLOCK

Decorative block installed at the bottom of a casing.

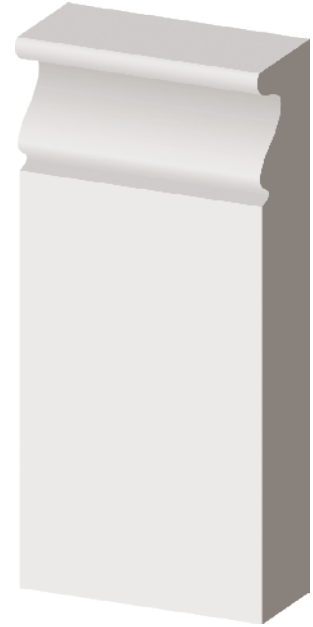

Stock Code
FFPPLIN
(1447812)
FFPPLIN412
(1447813)

Dimensions
1" x 3 5/8" x 9"

1" x 4 1/2" x 8"

MDF/UL

MULLION

The upright or vertical member dividing the panels in a door. A mullion is also the vertical member of a sash, window or door frame between openings in a multiple opening frame.

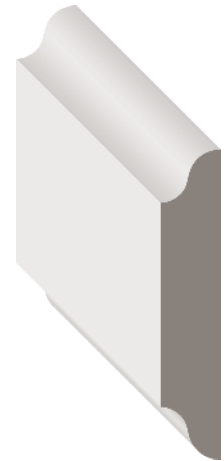

Stock Code
MP430D-08
(1544564)

Dimensions
5/16" x 1 5/8" x 8'

PFJ

QUARTER ROUND

Quarter Rounds come in several sizes and serve a variety of functions. They are most often used with baseboards.



Stock Code Dimensions
MTEK3206-08 $1\frac{1}{16}'' \times 1\frac{1}{16}'' \times 8'$
 (1329025)
MTEK3206-12 $1\frac{1}{16}'' \times 1\frac{1}{16}'' \times 12'$
 (1426842)

COM

MFJ21032 $1\frac{5}{16}'' \times 1\frac{5}{16}'' \times 8'$
 (1509648)
MFJ21031 $1\frac{5}{16}'' \times 1\frac{5}{16}'' \times 16'$
 (1543809)

FJR

MM12312 $\frac{7}{16}'' \times \frac{7}{16}'' \times 8'$
 (1448135)

MAH

MP21021 $1\frac{1}{16}'' \times 1\frac{1}{16}'' \times 16'$
 (1382368)
MP21022 $1\frac{1}{16}'' \times 1\frac{1}{16}'' \times 8'$
 (1382369)

PFJ

MSP12312 $\frac{7}{16}'' \times \frac{7}{16}'' \times 8'$
 (1448348)

MSP12321 $1\frac{1}{16}'' \times 1\frac{1}{16}'' \times 6-16'$
 (1544706)

MSP12322 $1\frac{1}{16}'' \times 1\frac{1}{16}'' \times 8'$
 (1448350)

MSP706-08 $1\frac{5}{16}'' \times 1\frac{5}{16}'' \times 8'$
 (1510319)

PIN

POP1237-08 $\frac{3}{4}'' \times \frac{3}{4}'' \times 8'$
 (1544871)

POP

PFP2102-08 $1\frac{1}{16}'' \times 1\frac{1}{16}'' \times 8'$
 (1544822)

PFP2102-16 $1\frac{1}{16}'' \times 1\frac{1}{16}'' \times 16'$
 (1544823)

PRI



Stock Code Dimensions
MP21002 $\frac{7}{16}'' \times \frac{7}{16}'' \times 8'$
 (1448196)

PFJ

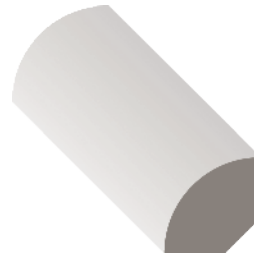

Stock Code Dimensions
MR012312 $\frac{1}{2}'' \times \frac{1}{2}'' \times 8'$
 (1510197)

O

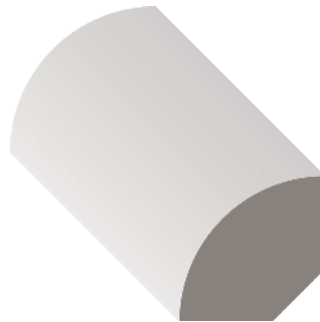

Stock Code Dimensions
MM12322 $\frac{5}{8}'' \times \frac{5}{8}'' \times 8'$
 (1448137)

MAH

MR03206 $\frac{3}{4}'' \times \frac{3}{4}''$
 (1626639)

MR012322 $\frac{3}{4}'' \times \frac{3}{4}'' \times 8'$
 (1382367)

O

V102S $1\frac{1}{16}'' \times 1\frac{1}{16}'' \times 8'$
 (1448607)

PVC

SCREEN MOULDS

A very versatile profile; screen Mould fits a wide variety of needs and uses. Traditionally used to hold mesh screening into wood screens, it also works well as edge trim on various shelving or wood trim for wallpaper.

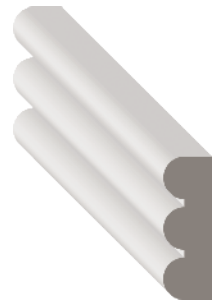

Stock Code Dimensions
MSP12622 $\frac{1}{4}'' \times \frac{3}{4}'' \times 8'$
 (1544727)

PIN

HALF ROUNDS

A cross section of a half round looks like a half circle and is used primarily as decorative trim. It works well as a trim piece for wallpaper or to add a decorative pattern to flat panels. This profile can also be used to put a rounded edge on various shelving.

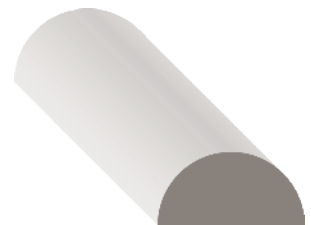

Stock Code Dimensions
MP421D-08 $\frac{5}{16}'' \times \frac{5}{8}'' \times 8'$
 (1544563)

PFJ

MSP12612 $\frac{5}{16}'' \times \frac{5}{8}'' \times 8'$
 (1510313)

PIN

MISCELLANEOUS

SHINGLE MOULDS

Originally used on the rake of a building or around exterior window frames. May also be used in applications similar to panel moulding.

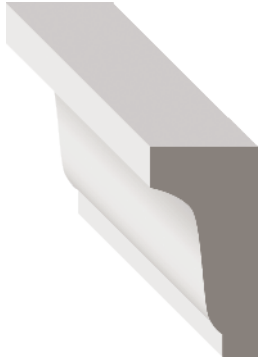

Stock Code
MR0825-08
(1544680)

Dimensions
 $\frac{7}{16}'' \times 1\frac{1}{8}'' \times 8'$

O

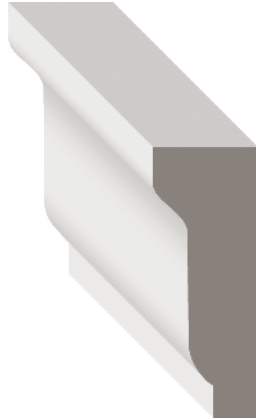

Stock Code
MP2189-16
(1544508)

Dimensions
 $\frac{7}{16}'' \times 1\frac{7}{16}'' \times 16'$

PFJ

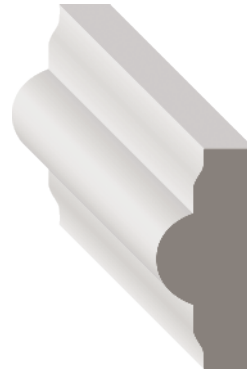

Stock Code
MFJ26962
(1543841)

Dimensions
 $\frac{1}{2}'' \times 1\frac{1}{8}'' \times 8'$

FJR

MP26962
(1448235)

$\frac{1}{2}'' \times 1\frac{1}{8}'' \times 8'$

PFJ

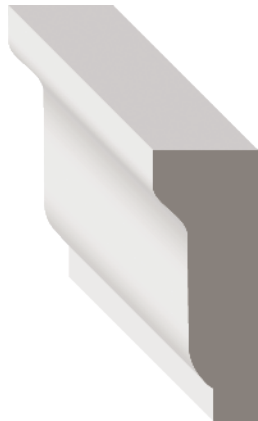

Stock Code
MSP12522
(1448356)

Dimensions
 $\frac{7}{16}'' \times 1\frac{1}{16}'' \times 8'$

PIN

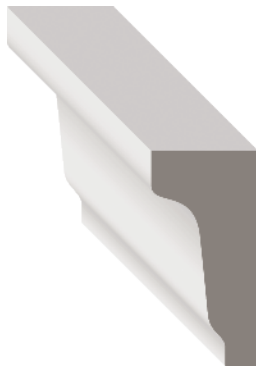

Stock Code
MM12512
(1544426)

Dimensions
 $\frac{7}{16}'' \times 1\frac{1}{8}'' \times 8'$

MAH

MP21881
(1544505)

$\frac{7}{16}'' \times 1\frac{1}{8}'' \times 16'$

MP21882
(1510142)

$\frac{7}{16}'' \times 1\frac{1}{8}'' \times 8'$

PFJ

MSP12512
(1448355)

$\frac{7}{16}'' \times 1\frac{1}{8}'' \times 8'$

PIN

SQUARES

Squares are used in the framing of shelves and cabinets, or are used to build up other profiles. Its uses are mostly utilitarian.



Stock Code
MP22292
(1544513)

Dimensions
 $1\frac{1}{16}'' \times 1\frac{1}{16}'' \times 8'$

PFJ

MISCELLANEOUS

SHIPLAPS

A wall paneling treatment made from wide wooden boards installed horizontally to create a rustic, cottage or coastal look.



Stock Code
1676393
1676391

Dimensions
 $\frac{1}{2}$ " x $5\frac{1}{2}$ " x 8'
 $\frac{1}{2}$ " x $5\frac{1}{2}$ " x 12'
COM

Stock Code
1676881
1676882

Dimensions
 $\frac{1}{2}$ " x $7\frac{1}{4}$ " x 8'
 $\frac{1}{2}$ " x $7\frac{1}{4}$ " x 12'
MDF/UL

Stock Code
MFP932TG-08
(1667862)

Dimensions
 $\frac{1}{32}$ " x $11\frac{1}{2}$ " x 8'

Stock Code
MFP932TG-12
(1667863)

Dimensions
 $\frac{1}{32}$ " x $11\frac{1}{2}$ " x 12'

Stock Code
MFP932TG-16
(1667864)

Dimensions
 $\frac{1}{32}$ " x $11\frac{1}{2}$ " x 16'

MDF/UL

WAINSCOT CAP

A wainscot cap is used to finish the top edge of a wainscot wall treatment. It may also be used as one component of a larger chair rail profile.

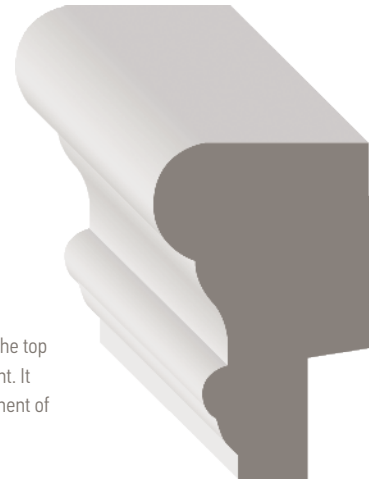

Stock Code
MFP850
(1009376)

Dimensions
 $1\frac{1}{8}$ " x $1\frac{1}{4}$ " x 8'

MDF/UL

WAINSCOT CAP & BASE



Stock Code
MFPWAINSET-96
(1626249)

Dimensions
 $\frac{5}{8}$ " x $2\frac{5}{8}$ " x 8'

MDF/UL

MISCELLANEOUS

WAINSCOT

Trimwork installed in the area below a chair rail. Numerous options are available including raised panel, shadow box and beaded. Combined with a chair rail and baseboard, wainscoting creates a dramatic look in any room.



Stock Code
MFP222
(1002119)

Dimensions
 $\frac{3}{8}$ " x 5 $\frac{3}{4}$ " x 10'

MDF/UL



Stock Code
MFP586TG-08
(1667859)

Dimensions
 $\frac{5}{8}$ " x 5 $\frac{7}{8}$ " x 8'

MFP586TG-16 $\frac{5}{8}$ " x 5 $\frac{7}{8}$ " x 16'

(1667861)

MDF/UL



Stock Code
MFP5812TG-08
(1543948)

Dimensions
 $\frac{5}{8}$ " x 11 $\frac{1}{4}$ " x 8'

MFP5812TG-12 $\frac{5}{8}$ " x 11 $\frac{1}{4}$ " x 12'

(1328417)

MFP5812TG-16 $\frac{5}{8}$ " x 11 $\frac{1}{4}$ " x 16'

(1328417)

MDF/UL



Stock Code Dimensions
LKP17106-10 $\frac{9}{16}$ " x 5 $\frac{1}{4}$ " x 10'
 (1543659)

KPIN

MFP722-96 $\frac{1}{4}$ " x 5 $\frac{1}{4}$ " x 8'
 (1328417)

MDF/UL



Stock Code Dimensions
MFP718-32 $\frac{1}{4}$ " x 7 $\frac{1}{8}$ " x 32"
 (1328412)

MFP718-96 $\frac{1}{4}$ " x 7 $\frac{1}{8}$ " x 8'
 (1328413)

MDF/UL



Stock Code Dimensions
MFP720-32 $\frac{1}{4}$ " x 7 $\frac{1}{8}$ " x 32"
 (1328414)

MFP720-96 $\frac{1}{4}$ " x 7 $\frac{1}{8}$ " x 8'
 (1328415)

MDF/UL

INDEX

Stock Code	Profile Type	Dimensions	Species	Page
1316205	Brick Mould	1-1/4" x 2" x 8'	PVC	47
1673692	Casing	3/4" x 3-1/2" x 8'	COM	28
1461282	Crown	1-3/16" x 6-5/16" x 8'	MDF/UL	38
1677110	Flat Stock	3/4" x 2-1/2" x 16'	PRI	45
1675313	Flat Stock	11/16" x 3-1/2" x 12'	COM	44
1484401	Flat Stock	3/4" x 3-1/2" x 16'	PRI	45
1679425	Flat Stock	11/16" x 3-1/2" x 16'	MDF/UL	44
1329018	Flat Stock	11/16" x 3-1/2" x 8'	COM	44
1677142	Flat Stock	3/4" x 4-1/2" x 16'	PRI	45
1675317	Flat Stock	3/4" x 5-1/2" x 12'	COM	44
1472867	Flat Stock	3/4" x 5-1/2" x 16'	PRI	45
1673771	Flat Stock	11/16" x 5-1/2" x 8'	COM	44
1472901	Flat Stock	3/4" x 7-1/4" x 16'	PRI	45
1676391	Shiplap	1/2" x 5-1/2" x 12'	COM	53
1676393	Shiplap	1/2" x 5-1/2" x 8'	COM	53
1676882	Shiplap	1/2" x 7-1/4" x 12'	MDF/UL	53
1676881	Shiplap	1/2" x 7-1/4" x 8'	MDF/UL	53
FFLCIC47 (1543565)	Crown Corner Block	5/8" x 4-1/4" x RL	MDF/UL	35
FFLCOC47 (1543565)	Crown Corner Block	5/8" x 4-1/4" x RL	MDF/UL	35
FF0300 (1543568)	Corner Block	7/8" x 3" x 3"	O	48
FFP250 (1447801)	Corner Block	5/8" x 2-1/2" x 2-1/2"	MDF/UL	48
FFP300 (1509384)	Corner Block	3/4" x 3" x 3"	MDF/UL	48
FFP300V (1509386)	Corner Block	7/8" x 3" x 3"	MDF/UL	48
FFPBOC (1447809)	Base Corner	7/8" x 7/8" x 9"	MDF/UL	48
FFPCIC8057 (1447810)	Crown Corner Block	5/8" x 3-5/16" x RL	MDF/UL	35
FFPCIC8058 (1543583)	Crown Corner Block	5/8" x 3-5/16" x RL	MDF/UL	35
FFPCOC8057 (1543584)	Crown Corner Block	5/8" x 3-5/16" x RL	MDF/UL	35
FFPCOC8058 (1543585)	Crown Corner Block	5/8" x 3-5/16" x RL	MDF/UL	35
FFPPLIN (1447812)	Plinth Block	3-5/8" x 9" x 1"	MDF/UL	50
FFPPLIN412 (1447813)	Plinth Block	4-1/2" x 8" x 1"	MDF/UL	50
FFSP300 (1447816)	Corner Block	5/8" x 3" x 3"	PIN	48
FFSPBIC (1447818)	Base Corner	3/4" x 3/4" x 6"	PIN	48
LKP1/204-06 (1509498)	Flat Stock	1/2" x 3-1/2" x 6'	KPIN	44
LKP1/204-08 (1509499)	Flat Stock	1/2" x 3-1/2" x 8'	KPIN	44
LKP1/206-08 (1509501)	Flat Stock	1/2" x 5-1/2" x 8'	KPIN	44
LKP102-06 (1509503)	Flat Stock	3/4" x 1-1/2" x 6'	KPIN	44
LKP102-08 (1509504)	Flat Stock	3/4" x 1-1/2" x 8'	KPIN	44
LKP103-08 (1509506)	Flat Stock	3/4" x 2-1/2" x 8'	KPIN	44
LKP104-06 (1509508)	Flat Stock	3/4" x 3-1/2" x 6'	KPIN	44
LKP104-08 (1509509)	Flat Stock	3/4" x 3-1/2" x 8'	KPIN	44
LKP105-04 (1447854)	Flat Stock	3/4" x 4-1/2" x 4'	KPIN	44
LKP105-06 (1447855)	Flat Stock	3/4" x 4-1/2" x 6'	KPIN	44
LKP105-08 (1509512)	Flat Stock	3/4" x 4-1/2" x 8'	KPIN	44
LKP106-04 (1447856)	Flat Stock	3/4" x 5-1/2" x 4'	KPIN	44
LKP106-06 (1447857)	Flat Stock	3/4" x 5-1/2" x 6'	KPIN	44
LKP106-08 (1447858)	Flat Stock	3/4" x 5-1/2" x 8'	KPIN	44
LKP106-10 (1509516)	Flat Stock	3/4" x 5-1/2" x 10'	KPIN	44
LKP108-06 (1509518)	Flat Stock	3/4" x 7-1/4" x 6'	KPIN	44
LKP108-08 (1447860)	Flat Stock	3/4" x 7-1/4" x 8'	KPIN	44
LKP108-10 (1447861)	Flat Stock	3/4" x 7-1/4" x 10'	KPIN	44
LKP110-04 (1674178)	Flat Stock	3/4" x 9-1/4" x 4'	KPIN	44
LKP110-08 (1447863)	Flat Stock	3/4" x 9-1/4" x 8'	KPIN	44
LKP112-04 (1674177)	Flat Stock	3/4" x 11-1/4" x 4'	KPIN	44
LKP112-06 (1447864)	Flat Stock	3/4" x 11-1/4" x 6'	KPIN	44
LKP112-08 (1543653)	Flat Stock	3/4" x 11-1/4" x 8'	KPIN	44
LKP17106-10 (1543659)	Wainscot	9/16" x 5-7/16" x 10'	KPIN	55

Stock Code	Profile Type	Dimensions	Species	Page
LKP202-06 (1509523)	Flat Stock	1-1/2" x 1-1/2" x 6'	KPIN	44
LKP202-08 (1509524)	Flat Stock	1-1/2" x 1-1/2" x 8'	KPIN	44
LKP204-08 (1509526)	Flat Stock	1-1/2" x 3-1/2" x 8'	KPIN	44
LMP102-04 (1328078)	Flat Stock	3/4" x 1-1/2" x 4'	MAP	44
LMP102-06 (1328079)	Flat Stock	3/4" x 1-1/2" x 6'	MAP	44
LMP102-08 (1447868)	Flat Stock	3/4" x 1-1/2" x 8'	MAP	44
LMP103-04 (1328082)	Flat Stock	3/4" x 2-1/2" x 4'	MAP	44
LMP103-06 (1328083)	Flat Stock	3/4" x 2-1/2" x 6'	MAP	44
LMP103-08 (1447871)	Flat Stock	3/4" x 2-1/2" x 8'	MAP	44
LMP104-04 (1328086)	Flat Stock	3/4" x 3-1/2" x 4'	MAP	44
LMP104-06 (1328087)	Flat Stock	3/4" x 3-1/2" x 6'	MAP	44
LMP104-08 (1447874)	Flat Stock	3/4" x 3-1/2" x 8'	MAP	44
LMP106-04 (1328091)	Flat Stock	3/4" x 5-1/2" x 4'	MAP	44
LMP106-06 (1328092)	Flat Stock	3/4" x 5-1/2" x 6'	MAP	44
LMP106-08 (1447877)	Flat Stock	3/4" x 5-1/2" x 8'	MAP	44
LMP108-04 (1328095)	Flat Stock	3/4" x 7-1/4" x 4'	MAP	44
LMP108-06 (1328096)	Flat Stock	3/4" x 7-1/4" x 6'	MAP	44
LMP108-08 (1447879)	Flat Stock	3/4" x 7-1/4" x 8'	MAP	44
LP1/2X2-3 (1328100)	Flat Stock	1/2" x 1-1/2" x 3'	POP	45
LP1/2X2-4 (1509543)	Flat Stock	1/2" x 1-1/2" x 4'	POP	45
LP1/2X3-3 (1328101)	Flat Stock	1/2" x 2-1/2" x 3'	POP	45
LP1/2X3-4 (1509545)	Flat Stock	1/2" x 2-1/2" x 4'	POP	45
LP1/2X4-3 (1328102)	Flat Stock	1/2" x 3-1/2" x 3'	POP	45
LP1/2X4-4 (1509547)	Flat Stock	1/2" x 3-1/2" x 4'	POP	45
LP1/2X6-3 (1328103)	Flat Stock	1/2" x 5-1/2" x 3'	POP	45
LP1/2X6-4 (1509549)	Flat Stock	1/2" x 5-1/2" x 4'	POP	45
LP1/2X2-4 (1328104)	Flat Stock	1/4" x 1-1/2" x 4'	POP	45
LP1/2X3-4 (1328105)	Flat Stock	1/4" x 2-1/2" x 4'	POP	45
LP1/2X4-4 (1328106)	Flat Stock	1/4" x 3-1/2" x 4'	POP	45
LP1/2X6-4 (1328107)	Flat Stock	1/4" x 5-1/2" x 4'	POP	45
LP1/2X8-4 (1543698)	Flat Stock	1/4" x 7-1/2" x 4'	POP	45
LP102-03 (1543699)	Flat Stock	3/4" x 1-1/2" x 3'	POP	45
LP102-04 (1328108)	Flat Stock	3/4" x 1-1/2" x 4'	POP	45
LP102-06 (1328109)	Flat Stock	3/4" x 1-1/2" x 6'	POP	45
LP102-10 (1002101)	Flat Stock	3/4" x 1-1/2" x 10'	POP	45
LP103-04 (1328111)	Flat Stock	3/4" x 2-1/2" x 4'	POP	45
LP103-06 (1328112)	Flat Stock	3/4" x 2-1/2" x 6'	POP	45
LP103-08 (1509565)	Flat Stock	3/4" x 2-1/2" x 8'	POP	45
LP104-03 (1543711)	Flat Stock	3/4" x 3-1/2" x 3'	POP	45
LP104-04 (1675260)	Flat Stock	3/4" x 3-1/2" x 4'	POP	45
LP104-06 (1328115)	Flat Stock	3/4" x 3-1/2" x 6'	POP	45
LP104-08 (1447892)	Flat Stock	3/4" x 3-1/2" x 8'	POP	45
LP104-10 (1007508)	Flat Stock	3/4" x 3-1/2" x 10'	POP	45
LP105-04 (1328117)	Flat Stock	3/4" x 4-1/2" x 4'	POP	45
LP105-06 (1328118)	Flat Stock	3/4" x 4-1/2" x 6'	POP	45
LP105-08 (1509571)	Flat Stock	3/4" x 4-1/2" x 8'	POP	45
LP105-10 (1543720)	Flat Stock	3/4" x 4-1/2" x 10'	POP	45
LP106-04 (1328120)	Flat Stock	3/4" x 5-1/2" x 4'	POP	45
LP106-06 (1328121)	Flat Stock	3/4" x 5-1/2" x 6'	POP	45
LP106-08 (1509574)	Flat Stock	3/4" x 5-1/2" x 8'	POP	45
LP106-10 (1006388)	Flat Stock	3/4" x 5-1/2" x 10'	POP	45
LP108-04 (1328123)	Flat Stock	3/4" x 7-1/4" x 4'	POP	45
LP108-06 (1328124)	Flat Stock	3/4" x 7-1/4" x 6'	POP	45
LP108-08 (1447895)	Flat Stock	3/4" x 7-1/4" x 8'	POP	45
LP108-10 (1005973)	Flat Stock	3/4" x 7-1/4" x 10'	POP	45
LP112-04 (1010779)	Flat Stock	3/4" x 11-1/4" x 4'	POP	45

INDEX

Stock Code	Profile Type	Dimensions	Species	Page
LP112-06 (1328128)	Flat Stock	3/4" x 11-1/4" x 6'	POP	45
LR01/2X3-3 (1328157)	Flat Stock	1/2" x 2-1/2" x 3'	O	44
LR01/2X4-3 (1328158)	Flat Stock	1/2" x 3-1/2" x 3'	O	44
LR01/2X6-3 (1328159)	Flat Stock	1/2" x 5-1/2" x 3'	O	44
LR01/4X4-4 (1328163)	Flat Stock	1/4" x 3-1/2" x 4'	O	45
LR01/4X6-4 (1328164)	Flat Stock	1/4" x 5-1/2" x 4'	O	45
LR0102-03 (1672820)	Flat Stock	3/4" x 1-1/2" x 3'	O	45
LR0102-04 (1328166)	Flat Stock	3/4" x 1-1/2" x 4'	O	45
LR0102-06 (1328167)	Flat Stock	3/4" x 1-1/2" x 6'	O	45
LR0102-08 (1447905)	Flat Stock	3/4" x 1-1/2" x 8'	O	45
LR0102-10 (1328169)	Flat Stock	3/4" x 1-1/2" x 10'	O	45
LR0103-04 (1328171)	Flat Stock	3/4" x 2-1/2" x 4'	O	45
LR0103-06 (1328172)	Flat Stock	3/4" x 2-1/2" x 6'	O	45
LR0103-08 (1008341)	Flat Stock	3/4" x 2-1/2" x 8'	O	45
LR0103-10 (1328174)	Flat Stock	3/4" x 2-1/2" x 10'	O	45
LR0104-04 (1328176)	Flat Stock	3/4" x 3-1/2" x 4'	O	45
LR0104-06 (1328177)	Flat Stock	3/4" x 3-1/2" x 6'	O	45
LR0104-08 (1447912)	Flat Stock	3/4" x 3-1/2" x 8'	O	45
LR0104-10 (1010613)	Flat Stock	3/4" x 3-1/2" x 10'	O	45
LR0105-04 (1328181)	Flat Stock	3/4" x 4-1/2" x 4'	O	45
LR0105-06 (1328182)	Flat Stock	3/4" x 4-1/2" x 6'	O	45
LR0105-08 (1447915)	Flat Stock	3/4" x 4-1/2" x 8'	O	45
LR0105-10 (1328184)	Flat Stock	3/4" x 4-1/2" x 10'	O	45
LR0106-04 (1328186)	Flat Stock	3/4" x 5-1/2" x 4'	O	45
LR0106-06 (1328187)	Flat Stock	3/4" x 5-1/2" x 6'	O	45
LR0106-08 (1447919)	Flat Stock	3/4" x 5-1/2" x 8'	O	45
LR0106-10 (1328189)	Flat Stock	3/4" x 5-1/2" x 10'	O	45
LR0108-04 (1328191)	Flat Stock	3/4" x 7-1/4" x 4'	O	45
LR0108-06 (1328192)	Flat Stock	3/4" x 7-1/4" x 6'	O	45
LR0108-08 (1447923)	Flat Stock	3/4" x 7-1/4" x 8'	O	45
LR0108-10 (1328194)	Flat Stock	3/4" x 7-1/4" x 10'	O	45
LR0112-04 (1328197)	Flat Stock	3/4" x 11-1/4" x 4'	O	45
LR0112-06 (1328198)	Flat Stock	3/4" x 11-1/4" x 6'	O	45
LSP102-04 (1509618)	Flat Stock	3/4" x 1-1/2" x 4'	PIN	45
LSP102-06 (1447924)	Flat Stock	3/4" x 1-1/2" x 6'	PIN	45
LSP102-08 (1447925)	Flat Stock	3/4" x 1-1/2" x 8'	PIN	45
LSP103-03 (1543778)	Flat Stock	3/4" x 2-1/2" x 3'	PIN	45
LSP103-04 (1509621)	Flat Stock	3/4" x 2-1/2" x 4'	PIN	45
LSP103-06 (1509622)	Flat Stock	3/4" x 2-1/2" x 6'	PIN	45
LSP103-08 (1447926)	Flat Stock	3/4" x 2-1/2" x 8'	PIN	45
LSP104-06 (1447927)	Flat Stock	3/4" x 3-1/2" x 6'	PIN	45
LSP104-08 (1447928)	Flat Stock	3/4" x 3-1/2" x 8'	PIN	45
LSP105-06 (1447929)	Flat Stock	3/4" x 4-1/2" x 6'	PIN	45
LSP105-08 (1509628)	Flat Stock	3/4" x 4-1/2" x 8'	PIN	45
LSP106-04 (1509629)	Flat Stock	3/4" x 5-1/2" x 4'	PIN	45
LSP106-06 (1509630)	Flat Stock	3/4" x 5-1/2" x 6'	PIN	45
LSP106-08 (1447932)	Flat Stock	3/4" x 5-1/2" x 8'	PIN	45
LSP108-08 (1447934)	Flat Stock	3/4" x 7-1/4" x 8'	PIN	45
LSP110-06 (1543795)	Flat Stock	3/4" x 9-1/4" x 6'	PIN	45
LSP110-08 (1543796)	Flat Stock	3/4" x 9-1/4" x 8'	PIN	45
MFJ102D-08 (1543797)	Flat Stock	3/4" x 1-1/2" x 8'	FJR	44
MFJ103D-08 (1509637)	Flat Stock	3/4" x 2-1/2" x 8'	FJR	44
MFJ104D-08 (1509638)	Flat Stock	3/4" x 3-1/2" x 8'	FJR	44
MFJ105D-08 (1509639)	Flat Stock	3/4" x 4-1/2" x 8'	FJR	44
MFJ106-16 (1543802)	Flat Stock	23/32" x 5-1/2" x 16'	FJR	44
MFJ106D-08 (1509640)	Flat Stock	3/4" x 5-1/2" x 8'	FJR	44

Stock Code	Profile Type	Dimensions	Species	Page
MFJ108-16 (1543805)	Flat Stock	23/32" x 7-1/4" x 16'	FJR	44
MFJ108D-08 (1509641)	Flat Stock	3/4" x 7-1/4" x 8'	FJR	44
MFJ108D-16 (1543807)	Flat Stock	3/4" x 7-1/4" x 8'	FJR	44
MFJ112D-08 (1543808)	Flat Stock	3/4" x 11-1/4" x 8'	FJR	44
MFJ21031 (1543809)	Quarter Round	15/16" x 15/16" x 16'	FJR	51
MFJ21032 (1509648)	Quarter Round	15/16" x 15/16" x 8'	FJR	51
MFJ21661 (1543811)	Burlap	1/4" x 1-3/16" x 16'	FJR	47
MFJ21961 (1543812)	Hand Rail	1-3/16" x 2-1/8" x 12'	FJR	48
MFJ2196141 (1543813)	Hand Rail	1-3/16" x 2-1/8" x 14'	FJR	48
MFJ2196161 (1543814)	Hand Rail	1-3/16" x 2-1/8" x 16'	FJR	48
MFJ21962 (1509664)	Hand Rail	1-3/16" x 2-1/8" x 8'	FJR	48
MFJ22272 (1543817)	Jamb	5/8" x 6-1/16" x 7'	FJR	46
MFJ22522 (1509669)	Jamb	9/16" x 4-9/16" x 7'	FJR	46
MFJ22582 (1447946)	Jamb	11/16" x 4-5/8" x 7'	FJR	46
MFJ22732 (1509674)	Door Stop	7/16" x 1-3/16" x 7'	FJR	42
MFJ25181 (1543826)	Baseboard	3/8" x 5-1/2" x 16'	PIN	12
MFJ25351 (1543827)	Brick Mould	1-1/4" x 2" x 16'	FJR	47
MFJ25352 (1509675)	Brick Mould	1-1/4" x 2" x 8'	FJR	47
MFJ26912 (1543837)	Door Stop	3/8" x 7/8" x 85"	FJR	43
MFJ26962 (1543841)	Shingle Mould	1/2" x 1-1/8" x 8'	FJR	52
MFJ29001D (1543843)	Casing	9/16" x 2-3/4" x 170"	FJR	23
MFJ29002 (1509688)	Casing	9/16" x 2-3/4" x 85"	FJR	23
MFJ2900CB1D (1543845)	Casing	1" x 3" x 171"	FJR	27
MFJ2900CB2 (1543847)	Casing	1" x 3" x 86"	FJR	27
MFJ2900I1 (1509689)	Casing	9/16" x 2-3/4" x 170"	FJR	23
MFJ2900I2 (1543850)	Casing	9/16" x 2-3/4" x 85"	FJR	23
MFJ29111 (1543851)	Baseboard	1/2" x 4-1/8" x 16'	PIN	11
MFJ291611 (1543854)	Baseboard	3/8" x 4" x 16'	FJR	11
MFP1223-14 (1543865)	Door Stop	7/16" x 1-1/4" x 14'	MDF/UL	43
MFP1223-98 (1663061)	Door Stop	7/16" x 1-1/4" x 98"	MDF/UL	43
MFP1408-VP (1328256)	Flat Stock	1/2" x 3-1/2" x 8'	MDF/UL	44
MFP1802-08 (1543876)	Flat Stock	23/32" x 1-1/2" x 8'	MDF/UL	44
MFP1802-12 (1543877)	Flat Stock	23/32" x 1-1/2" x 12'	MDF/UL	44
MFP1803-08 (1543878)	Flat Stock	11/16" x 2-1/2" x 8'	MDF/UL	44
MFP1803-12 (1543879)	Flat Stock	11/16" x 2-1/2" x 12'	MDF/UL	44
MFP1804-08 (1543880)	Flat Stock	11/16" x 3-1/2" x 8'	MDF/UL	44
MFP1804-12 (1543881)	Flat Stock	11/16" x 3-1/2" x 12'	MDF/UL	44
MFP1805-08 (1543882)	Flat Stock	11/16" x 4-9/16" x 8'	MDF/UL	44
MFP1805-12 (1543883)	Flat Stock	11/16" x 4-9/16" x 12'	MDF/UL	44
MFP1806-08 (1543884)	Flat Stock	11/16" x 5-1/2" x 8'	MDF/UL	44
MFP1806-12 (1543885)	Flat Stock	11/16" x 5-1/2" x 12'	MDF/UL	44
MFP1808-08 (1543886)	Flat Stock	11/16" x 7-1/4" x 8'	MDF/UL	44
MFP1808-12 (1543887)	Flat Stock	11/16" x 7-1/4" x 12'	MDF/UL	44
MFP1X12-08 (1010156)	Flat Stock	5/8" x 11-1/4" x 8'	MDF/UL	44
MFP1X2-08 (1447950)	Flat Stock	9/16" x 1-1/2" x 8'	MDF/UL	44
MFP1X2-12 (1009631)	Flat Stock	9/16" x 1-1/2" x 12'	MDF/UL	44
MFP1X3-08 (1447951)	Flat Stock	9/16" x 2-1/2" x 8'	MDF/UL	44
MFP1X3-12 (1003824)	Flat Stock	9/16" x 2-1/2" x 12'	MDF/UL	44
MFP1X4-08 (1447952)	Flat Stock	9/16" x 3-1/2" x 8'	MDF/UL	44
MFP1X4-12 (1009825)	Flat Stock	9/16" x 3-1/2" x 12'	MDF/UL	44
MFP1X5-08 (1447953)	Flat Stock	9/16" x 4-1/2" x 8'	MDF/UL	44
MFP1X5-12 (1509760)	Flat Stock	9/16" x 4-1/2" x 12'	MDF/UL	44
MFP1X6-08 (1447954)	Flat Stock	9/16" x 5-1/2" x 8'	MDF/UL	44
MFP1X6-12 (1509764)	Flat Stock	9/16" x 5-1/2" x 12'	MDF/UL	44
MFP1X6-16 (1006289)	Flat Stock	9/16" x 5-1/2" x 16'	MDF/UL	44
MFP1X8-08 (1447955)	Flat Stock	9/16" x 7-1/4" x 8'	MDF/UL	44

INDEX

Stock Code	Profile Type	Dimensions	Species	Page
MFP1X8-12 (1509768)	Flat Stock	3/16" x 7-1/4" x 12'	MDF/UL	44
MFP222 (1002119)	Wainscot	3/8" x 5-3/4" x 10'	MDF/UL	54
MFP3561 (1447959)	Casing	7/16" x 2-1/4" x 14'	MDF/UL	21
MFP3562 (1447960)	Casing	7/16" x 2-1/4" x 85"	MDF/UL	21
MFP4429-08 (1509786)	Baseboard	5/8" x 5-1/2" x 8'	MDF/UL	12
MFP4429-16 (1039489)	Baseboard	5/8" x 5-1/2" x 16'	MDF/UL	12
MFP4494-08 (1039555)	Casing	3/4" x 3-1/2" x 8'	MDF/UL	28
MFP4494-16 (1509797)	Casing	3/4" x 3-1/2" x 16'	MDF/UL	28
MFP5812TG-08 (1543948)	Wainscot	5/8" x 11-1/4" x 8'	MDF/UL	54
MFP5812TG-12 (1543950)	Wainscot	5/8" x 11-1/4" x 12'	MDF/UL	54
MFP5812TG-16 (1543952)	Wainscot	5/8" x 11-1/4" x 16'	MDF/UL	54
MFP586TG-08 (1667859)	Wainscot	5/8" x 5-7/8" x 8'	MDF/UL	54
MFP586TG-16 (1667861)	Wainscot	5/8" x 5-7/8" x 16'	MDF/UL	54
MFP606-08 (1509806)	Baseboard	1/2" x 4-1/8" x 8'	MDF/UL	10
MFP606-14 (1509807)	Baseboard	1/2" x 4-1/8" x 14'	MDF/UL	10
MFP718-32 (1328412)	Wainscot	1/4" x 7-1/8" x 32"	MDF/UL	55
MFP718-96 (1328413)	Wainscot	1/4" x 7-1/8" x 8'	MDF/UL	55
MFP720-32 (1328414)	Wainscot	1/4" x 7-1/8" x 32"	MDF/UL	55
MFP720-96 (1328415)	Wainscot	1/4" x 7-1/8" x 8'	MDF/UL	55
MFP722-96 (1328417)	Wainscot	1/4" x 5-1/4" x 8'	MDF/UL	55
MFP80311 (1447967)	Casing	11/16" x 3-1/2" x 171"	MDF/UL	26
MFP803182 (1447968)	Casing	11/16" x 3-1/2" x 8'	MDF/UL	26
MFP80321 (1509841)	Casing	9/16" x 2-13/16" x 14'	MDF/UL	26
MFP80322 (1509842)	Casing	9/16" x 2-13/16" x 7'	MDF/UL	26
MFP8036BB-08 (1543983)	Casing	1-1/8" x 3-1/4" x 8'	MDF/UL	26
MFP8036BB-16 (1543985)	Casing	1-1/8" x 3-1/4" x 16'	MDF/UL	26
MFP8037-14 (1543987)	Casing	3/4" x 2-3/4" x 169"	MDF/UL	25
MFP80372 (1008857)	Casing	3/4" x 2-3/4" x 7'	MDF/UL	25
MFP8038CB-16 (1544000)	Casing	1" x 3" x 16'	MDF/UL	26
MFP80391 (1039342)	Casing	3/4" x 3-1/2" x 16'	MDF/UL	25
MFP80392 (1328422)	Casing	3/4" x 3-1/2" x 8'	MDF/UL	25
MFP8043A (1673636)	Crown	3/4" x 6-7/8" x 8'	MDF/UL	37
MFP8043A-16 (1544009)	Crown	3/4" x 6-7/8" x 16'	MDF/UL	37
MFP8044 (1544010)	Casing	1-1/8" x 3-1/2" x 16'	MDF/UL	27
MFP8048B1 (1509856)	Crown	9/16" x 4-1/8" x 12'	MDF/UL	36
MFP8048B2 (1509858)	Crown	9/16" x 4-1/8" x 8'	MDF/UL	36
MFP8051S-12 (1544019)	Crown	5/8" x 5-1/4" x 12'	MDF/UL	39
MFP80571 (1447971)	Crown	1/2" x 3-1/16" x 12'	MDF/UL	35
MFP80572 (1447973)	Crown	1/2" x 3-1/16" x 8'	MDF/UL	35
MFP8058-08 (1509864)	Crown	1/2" x 3-5/16" x 8'	MDF/UL	39
MFP8058-12 (1509865)	Crown	1/2" x 3-5/16" x 12'	MDF/UL	39
MFP80581 (1447975)	Crown	1/2" x 3-5/16" x 12'	MDF/UL	39
MFP8062B1 (1447977)	Casing	3/4" x 3-7/8" x 14'	MDF/UL	29
MFP8062B2 (1447978)	Casing	3/4" x 3-7/8" x 7'	MDF/UL	29
MFP80651 (1544031)	Casing	3/4" x 3-1/2" x 16'	MDF/UL	29
MFP806582 (1509868)	Casing	3/4" x 3-1/2" x 8'	MDF/UL	29
MFP80702 (1447980)	Casing	3/4" x 2-3/4" x 7'	MDF/UL	22
MFP80751 (1544035)	Casing	3/4" x 3" x 16'	MDF/UL	22
MFP80871 (1544038)	Casing	1-1/8" x 3-1/2" x 169"	MDF/UL	27
MFP80872 (1544040)	Casing	1-1/8" x 3-1/2" x 8'	MDF/UL	27
MFP80951 (1006014)	Baseboard	1/2" x 5-1/8" x 12'	MDF/UL	16
MFP8095141 (1544044)	Baseboard	1/2" x 5-1/8" x 14'	MDF/UL	16
MFP80952 (1509872)	Baseboard	1/2" x 5-1/8" x 8'	MDF/UL	16
MFP81092 (1544051)	Jamb	3/4" x 4-5/8" x 7'	MDF/UL	46
MFP8116-14 (1544052)	Door Stop	1/2" x 1-1/8" x 14'	MDF/UL	42
MFP8119-08 (1667878)	Door Stop	3/8" x 1-1/4" x 8'	MDF/UL	43

Stock Code	Profile Type	Dimensions	Species	Page
MFP8119-14 (1544053)	Door Stop	3/8" x 1-1/4" x 14'	MDF/UL	43
MFP82232 (1509880)	Jamb	5/8" x 4-9/16" x 7'	MDF/UL	46
MFP8223T2 (1544064)	Jamb	5/8" x 4-5/8" x 84"	MDF/UL	46
MFP82272 (1544065)	Jamb	5/8" x 6-5/8" x 7'	MDF/UL	46
MFP82341 (1447993)	Baseboard	9/16" x 5-1/2" x 12'	MDF/UL	15
MFP8234161 (1544068)	Baseboard	9/16" x 5-1/2" x 16'	MDF/UL	15
MFP82342 (1447994)	Baseboard	9/16" x 5-1/2" x 8'	MDF/UL	15
MFP82351 (1509883)	Baseboard	5/8" x 7-1/4" x 12'	MDF/UL	17
MFP8236-08 (1007059)	Baseboard	3/8" x 3-7/8" x 8'	MDF/UL	14
MFP82361 (1509884)	Baseboard	3/8" x 3-7/8" x 14'	MDF/UL	14
MFP82371 (1039334)	Baseboard	5/8" x 5-1/2" x 12'	MDF/UL	18
MFP82372 (1509886)	Baseboard	5/8" x 5-1/2" x 8'	MDF/UL	18
MFP82391 (1447995)	Baseboard	5/8" x 7-1/4" x 12'	MDF/UL	18
MFP82392 (1447996)	Baseboard	5/8" x 7-1/4" x 8'	MDF/UL	18
MFP82701 (1447997)	Baseboard	5/8" x 5-1/4" x 12'	MDF/UL	12
MFP82702 (1447998)	Baseboard	5/8" x 5-1/4" x 8'	MDF/UL	12
MFP82751 (1544097)	Baseboard	5/8" x 5-1/2" x 12'	MDF/UL	17
MFP82871 (1544099)	Baseboard	5/8" x 7-1/4" x 12'	MDF/UL	17
MFP83001 (1448003)	Chair Rail	9/16" x 1-3/4" x 12'	MDF/UL	30
MFP83002 (1008285)	Chair Rail	9/16" x 1-3/4" x 8'	MDF/UL	30
MFP83032 (1544106)	Door Stop	3/8" x 1-5/8" x 7'	MDF/UL	42
MFP8319-07 (1509903)	Door Stop	3/8" x 1-1/4" x 7'	MDF/UL	43
MFP8319-14 (1509904)	Door Stop	3/8" x 1-1/4" x 14'	MDF/UL	43
MFP8320-08 (1509905)	Baseboard	1/2" x 4-3/4" x 8'	MDF/UL	17
MFP8320-08 (1509905)	Baseboard	1/2" x 4-3/4" x 8'	MDF/UL	17
MFP8323-07 (1544114)	Casing	5/8" x 2-3/4" x 7'	MDF/UL	28
MFP8323-08 (1544115)	Casing	5/8" x 2-3/4" x 8'	MDF/UL	28
MFP8334 (1544119)	Baseboard	1/2" x 5-1/2" x 12'	MDF/UL	15
MFP8334-14 (1005268)	Baseboard	1/2" x 5-1/2" x 14'	MDF/UL	15
MFP8338-08 (1004722)	Casing	5/8" x 3-3/8" x 8'	MDF/UL	29
MFP8345-07 (1509912)	Casing	5/8" x 2-3/4" x 7'	MDF/UL	25
MFP8345-14 (1509915)	Casing	5/8" x 2-3/4" x 14'	MDF/UL	25
MFP83901 (1509921)	Chair Rail	5/8" x 2-1/2" x 12'	MDF/UL	30
MFP83902 (1448006)	Chair Rail	5/8" x 2-1/2" x 8'	MDF/UL	30
MFP8490-07 (1544148)	Casing	1/2" x 2" x 7'	MDF/UL	28
MFP850 (1009376)	Wainscot Cap	1-1/8" x 1-3/4" x 8'	MDF/UL	53
MFP85121 (1448008)	Crown	9/16" x 5-3/8" x 12'	MDF/UL	36
MFP85122 (1509928)	Crown	9/16" x 5-3/8" x 8'	MDF/UL	36
MFP85711 (1544170)	Crown	1" x 7-1/4" x 12'	MDF/UL	37
MFP8621B1 (1509929)	Casing	3/8" x 3-1/8" x 14'	MDF/UL	21
MFP8621B2 (1509930)	Casing	3/8" x 2-1/8" x 7'	MDF/UL	21
MFP8622B1 (1448015)	Baseboard	3/8" x 3-1/8" x 12'	MDF/UL	9
MFP8622B2 (1448016)	Baseboard	3/8" x 3-1/8" x 8'	MDF/UL	9
MFP8662B2 (1509936)	Door Stop	3/8" x 1-3/8" x 7'	MDF/UL	42
MFP86642 (1544192)	Door Stop	7/16" x 1-1/4" x 85"	MDF/UL	42
MFP8696-12 (1010755)	Crown	11/16" x 5-7/8" x 12'	MDF/UL	40
MFP87061 (1509942)	Baseboard	3/8" x 3-7/8" x 12'	MDF/UL	10
MFP87062 (1006251)	Baseboard	3/8" x 3-7/8" x 8'	MDF/UL	10
MFP8706IN-14 (1039502)	Baseboard	3/8" x 3-7/8" x 14'	MDF/UL	10
MFP88571 (1544206)	Baseboard	3/8" x 3-1/4" x 12'	MDF/UL	12
MFP88572 (1544207)	Baseboard	3/8" x 3-1/4" x 8'	MDF/UL	12
MFP88821 (1448030)	Crown	5/8" x 4-1/2" x 12'	MDF/UL	37
MFP88822 (1509955)	Crown	5/8" x 4-1/2" x 8'	MDF/UL	37
MFP8900B1 (1509958)	Casing	9/16" x 2-3/4" x 169"	MDF/UL	23
MFP8900B2 (1509960)	Casing	9/16" x 2-3/4" x 85"	MDF/UL	23
MFP89101 (1448036)	Baseboard	3/8" x 3-7/8" x 12'	MDF/UL	10

INDEX

Stock Code	Profile Type	Dimensions	Species	Page
MFP8910161 (1544226)	Baseboard	3/8" x 3-7/8" x 16'	MDF/UL	10
MFP89102 (1448037)	Baseboard	3/8" x 3-7/8" x 8'	MDF/UL	10
MFP89151 (1448038)	Baseboard	1/2" x 7-1/4" x 12'	MDF/UL	16
MFP89152 (1448039)	Baseboard	1/2" x 7-1/4" x 8'	MDF/UL	16
MFP89541 (1448040)	Casing	1 1/16" x 3-1/2" x RL	MDF/UL	24
MFP895482 (1448041)	Casing	1 1/16" x 3-1/2" x 8'	MDF/UL	24
MFP8955-14 (1509974)	Baseboard	9/16" x 5-9/16" x 14'	MDF/UL	16
MFP89551 (1448042)	Baseboard	9/16" x 5-9/16" x 12'	MDF/UL	16
MFP89552 (1448043)	Baseboard	9/16" x 5-9/16" x 8'	MDF/UL	16
MFP89772 (1509976)	Casing	3/4" x 3-1/16" x 8'	MDF/UL	29
MFP932TG-08 (1667862)	Shi lap	19/32" x 11-1/2" x 8'	MDF/UL	53
MFP932TG-12 (1667863)	Shi lap	19/32" x 11-1/2" x 12'	MDF/UL	53
MFP932TG-16 (1667864)	Shi lap	19/32" x 11-1/2" x 16'	MDF/UL	53
MFP104-08 (1005832)	Flat Stock	23/32" x 3-1/2" x 8'	MDF/UL	44
MFP106-08 (1002084)	Flat Stock	1 1/16" x 5-1/2" x 8'	MDF/UL	44
MFP2518 (1544266)	Baseboard	3/8" x 5-1/2" x 12'	MDF/UL	12
MFP25182 (1544267)	Baseboard	3/8" x 5-1/2" x 8'	MDF/UL	12
MFP2900CB (1544271)	Casing	1" x 3" x 15'	MDF/UL	27
MFP2900CB2 (1002482)	Casing	1" x 3" x 90"	MDF/UL	27
MFP41 (1626152)	Crown	1-3/16" x 6-5/16" x 16'	MDF/UL	38
MFP411 (1328502)	Casing	1 1/16" x 3" x 16'	MDF/UL	24
MFP4112 (1509998)	Casing	1 1/16" x 3" x 8'	MDF/UL	24
MFP412 (1328503)	Baseboard	9/16" x 4-1/4" x 16'	MDF/UL	10
MFP4122 (1510002)	Baseboard	9/16" x 4-1/4" x 8'	MDF/UL	10
MFP443 (1555825)	Crown	1" x 6-5/16" x 16'	MDF/UL	38
MFP47 (1626166)	Crown	5/8" x 4-1/4" x 16'	MDF/UL	35
MFP47-08 (1448066)	Crown	5/8" x 4-1/4" x 8'	MDF/UL	35
MFP5000 (1045933)	Architrave	1-1/8" x 3-3/4" x 12'	MDF/UL	6
MFP50002 (1448071)	Architrave	1-1/8" x 3-3/4" x 8'	MDF/UL	6
MFP5015 (1328514)	Architrave	1-1/2" x 5-1/2" x 12'	MDF/UL	6
MFP5015-08 (1448073)	Architrave	1-1/2" x 5-1/2" x 8'	MDF/UL	6
MFP5020 (1005107)	Architrave	1-3/16" x 5-1/4" x 12'	MDF/UL	6
MFP5020-08 (1448075)	Architrave	1-3/16" x 5-1/4" x 8'	MDF/UL	6
MFP5212 (1544294)	Crown	1 1/16" x 2-1/2" x 8'	MDF/UL	34
MFP535 (1610431)	Casing	1 1/16" x 3-1/2" x 16'	MDF/UL	24
MFP5352 (1448082)	Casing	1 1/16" x 3-1/2" x 8'	MDF/UL	24
MFP545 (1341818)	Baseboard	9/16" x 5" x 16'	MDF/UL	15
MFP5452 (1448085)	Baseboard	9/16" x 5" x 8'	MDF/UL	15
MFP60 (1544300)	Crown	1 1/16" x 5-1/2" x 16'	MDF/UL	40
MFP712 (1448088)	Crown	1 1/16" x 4-1/2" x 16'	MDF/UL	40
MFP7122 (1448089)	Crown	1 1/16" x 4-1/2" x 8'	MDF/UL	40
MFP8063 (1448090)	Casing	1 1/16" x 3-1/4" x 16'	MDF/UL	22
MFP80632 (1448091)	Casing	1 1/16" x 3-1/4" x 8'	MDF/UL	22
MFP8243 (1005901)	Baseboard	1/2" x 4-1/4" x 12'	MDF/UL	14
MFP82432 (1544310)	Baseboard	1/2" x 4-1/4" x 8'	MDF/UL	14
MFP8263 (1341833)	Baseboard	9/16" x 6-1/2" x 16'	MDF/UL	13
MFP82632 (1448094)	Baseboard	9/16" x 6-1/2" x 8'	MDF/UL	13
MFP900 (1328541)	Crown	1-3/16" x 5-1/4" x 16'	MDF/UL	41
MFP900-08 (1328542)	Crown	1-3/16" x 5-1/4" x 8'	MDF/UL	41
MFP901 (1544317)	Crown	1-3/16" x 6-3/4" x 12'	MDF/UL	41
MFP901-08 (1007269)	Crown	1-3/16" x 6-3/4" x 8'	MDF/UL	41
MFP9090 (1039485)	Casing	5/8" x 3" x 16'	MDF/UL	28
MFP9090-08 (1039349)	Casing	5/8" x 3" x 8'	MDF/UL	28
MFP9091 (1039352)	Casing	5/8" x 3-1/2" x 16'	MDF/UL	28
MFP9091-08 (1039482)	Casing	5/8" x 3-1/2" x 8'	MDF/UL	28
MFP9290 (1039350)	Baseboard	1/2" x 5" x 12'	MDF/UL	13

Stock Code	Profile Type	Dimensions	Species	Page
MFP9290-08 (1039348)	Baseboard	1/2" x 5" x 8'	MDF/UL	13
MFP9291 (1045991)	Baseboard	1/2" x 6-1/2" x 12'	MDF/UL	13
MFP9291-08 (1039503)	Baseboard	1/2" x 6-1/2" x 8'	MDF/UL	13
MFPWAINSET-96 (1626249)	Wainscot	9/16" x 2-5/8" x 96"	MDF/UL	53
MKC823-96 (1328657)	T&G Paneling	5/16" x 3-9/16" x 8'	MKC	49
MKP823B-32 (1510071)	T&G Paneling	5/16" x 3-9/16" x 32"	KPIN	49
MKP823B-48 (1328666)	T&G Paneling	5/16" x 3-9/16" x 4'	KPIN	49
MKP823B-96 (1328667)	T&G Paneling	5/16" x 3-9/16" x 8'	KPIN	49
MKP823P-96 (1448123)	T&G Paneling	5/16" x 3-9/16" x 96"	KPIN	49
MKP823V-96 (1328668)	T&G Paneling	5/16" x 3-9/16" x 8'	KPIN	49
MM12012 (1448126)	Casing	3/8" x 2-1/8" x 7'	MAH	20
MM12051 (1544401)	Casing	7/16" x 2-1/4" x RL	MAH	20
MM12052 (1544402)	Casing	7/16" x 2-1/4" x 7'	MAH	20
MM12072 (1544404)	Casing	9/16" x 2-7/16" x 7'	MAH	23
MM12092 (1448128)	Casing	9/16" x 2-3/4" x 7'	MAH	23
MM12102 (1448130)	Baseboard	5/16" x 3-1/8" x 8'	MAH	8
MM12121 (1544409)	Baseboard	3/8" x 3" x RL	MAH	9
MM12122 (1448131)	Baseboard	3/8" x 3" x 8'	MAH	9
MM12152 (1544412)	Baseboard	7/16" x 4-1/8" x 8'	MAH	11
MM12232 (1448134)	Door Stop	3/8" x 1-1/4" x 7'	MAH	42
MM12262 (1544416)	Burlap	5/16" x 1-1/2" x 8'	MAH	47
MM12312 (1448135)	Quarter Round	7/16" x 7/16" x 8'	MAH	51
MM12322 (1448137)	Quarter Round	5/8" x 5/8" x 8'	MAH	51
MM12342 (1448138)	Baseboard Shoe	3/8" x 3/4" x 8'	MAH	19
MM12422 (1448140)	Cove	1 1/16" x 1 1/16" x 8'	MAH	33
MM12512 (1544426)	Shingle Mould	7/16" x 1-1/8" x 8'	MAH	52
MM12631 (1544433)	Hand Rail	7/8" x 2-1/2" x RL	MAH	48
MM12752 (1544434)	Jamb	1 1/16" x 4-9/16" x 7'	MAH	46
MP1258-08 (1448166)	Ply Cap	7/8" x 1-5/8" x 8'	PFJ	50
MP1X12-08 (1544459)	Flat Stock	23/32" x 11-1/4" x 8'	PFJ	45
MP1X22 (1544460)	Flat Stock	23/32" x 1-1/2" x 8'	PFJ	45
MP1X32 (1544461)	Flat Stock	23/32" x 2-1/2" x 8'	PFJ	45
MP1X42 (1448184)	Flat Stock	23/32" x 3-1/2" x 8'	PFJ	45
MP1X52 (1448186)	Flat Stock	23/32" x 4-1/2" x 8'	PFJ	45
MP1X62 (1448188)	Flat Stock	23/32" x 5-1/2" x 8'	PFJ	45
MP1X82 (1448190)	Flat Stock	23/32" x 7-1/4" x 8'	PFJ	45
MP20701 (1544466)	Door Stop	5/16" x 1" x 14'	PFJ	43
MP20702 (1448194)	Door Stop	5/16" x 1" x 7'	PFJ	43
MP21002 (1448196)	Quarter Round	7/16" x 7/16" x 8'	PFJ	51
MP21011 (1448197)	Baseboard Shoe	3/8" x 1 1/16" x 16'	PFJ	19
MP21012 (1448198)	Baseboard Shoe	3/8" x 1 1/16" x 8'	PFJ	19
MP21021 (1382368)	Quarter Round	1 1/16" x 1 1/16" x 16'	PFJ	51
MP21022 (1382369)	Quarter Round	1 1/16" x 1 1/16" x 8'	PFJ	51
MP21052 (1448201)	Cove	1/2" x 1/2" x 8'	PFJ	33
MP21061 (1448202)	Cove	1 1/16" x 1 1/16" x 16'	PFJ	33
MP21062 (1382343)	Cove	1 1/16" x 1 1/16" x 8'	PFJ	33
MP21102 (1448204)	Casing	3/8" x 2-1/8" x 14'	PFJ	20
MP21102 (1448205)	Casing	3/8" x 2-1/8" x 7'	PFJ	20
MP2114-08 (1448206)	Door Stop	1/2" x 1-1/4" x 8'	PFJ	42
MP21301 (1448208)	Baseboard	5/16" x 3-1/8" x 16'	PFJ	8
MP21302 (1448209)	Baseboard	5/16" x 3-1/8" x 8'	PFJ	8
MP2131-08 (1544488)	Baseboard Shoe	7/16" x 1 1/16" x 8'	PFJ	19
MP2131-12 (1544489)	Baseboard Shoe	7/16" x 1 1/16" x 12'	PFJ	19
MP2163-08 (1544493)	Baseboard Cap	5/8" x 1-3/8" x 8'	PFJ	19
MP2163-12 (1544494)	Baseboard Cap	5/8" x 1-3/8" x 12'	PFJ	19
MP21662 (1448210)	Burlap	1/4" x 1-3/16" x 8'	PFJ	47

INDEX

Stock Code	Profile Type	Dimensions	Species	Page
MP21672 (1544496)	Burlap	1/4" x 1-1/16" x 8'	PFJ	47
MP21702 (1448211)	Corner Guard	11/16" x 11/16" x 8'	PFJ	32
MP21712 (1448212)	Corner Guard	5/16" x 15/16" x 8'	PFJ	32
MP2173-08 (1448214)	Crown	7/16" x 1-5/8" x 8'	PFJ	34
MP21742 (1544501)	Crown	7/16" x 2-1/8" x 8'	PFJ	34
MP21801 (1448215)	Crown	9/16" x 4-1/2" x 16'	PFJ	34
MP21881 (1544505)	Shingle Mould	9/16" x 1-1/8" x 16'	PFJ	52
MP21882 (1510142)	Shingle Mould	9/16" x 1-1/8" x 8'	PFJ	52
MP2189-16 (1544508)	Shingle Mould	9/16" x 1-3/16" x 16'	PFJ	52
MP21961 (1448219)	Hand Rail	1-3/16" x 2-1/8" x 12'	PFJ	48
MP22272 (1544510)	Jamb	5/8" x 6-5/8" x 7'	PFJ	46
MP22282 (1544512)	Flat Stock	13/32" x 21/32" x 8'	PFJ	45
MP22292 (1544513)	Square	11/16" x 11/16" x 8'	PFJ	52
MP22522 (1510149)	Jamb	9/16" x 4-9/16" x 7'	PFJ	46
MP22582 (1544515)	Jamb	11/16" x 4-5/8" x 7'	PFJ	46
MP22731 (1510154)	Door Stop	7/16" x 1-3/16" x 14'	PFJ	42
MP22732 (1510155)	Door Stop	7/16" x 1-3/16" x 7'	PFJ	42
MP2298-08 (1544520)	Chair Rail	5/8" x 2-1/2" x 8'	PFJ	31
MP2298-12 (1544521)	Chair Rail	5/8" x 2-1/2" x 12'	PFJ	31
MP2356-07 (1544522)	Casing	21/32" x 2-1/4" x 7'	PFJ	22
MP2381T-12 (1544524)	Door Stop	3/8" x 1" x 12'	PFJ	43
MP24102 (1510156)	Lattice	1/4" x 1-1/16" x 8'	PFJ	49
MP26071 (1510157)	Baseboard	5/16" x 2-15/16" x 16'	PFJ	9
MP26072 (1448227)	Baseboard	5/16" x 2-15/16" x 8'	PFJ	9
MP26211 (1544529)	Casing	3/8" x 2-1/16" x 7'	PFJ	21
MP26212 (1448229)	Casing	3/8" x 2-1/16" x 7'	PFJ	21
MP26252 (1544535)	Casing	3/8" x 1-15/16" x 7'	PFJ	21
MP26902 (1544538)	Chair Rail	1" x 2-3/8" x 8'	PFJ	31
MP26962 (1448235)	Shingle Mould	1/2" x 1-1/8" x 8'	PFJ	52
MP27102 (1448237)	Casing	5/8" x 2-1/2" x 7'	PFJ	23
MP29001 (1448238)	Casing	9/16" x 2-3/4" x 170"	PFJ	23
MP29002 (1448239)	Casing	9/16" x 2-3/4" x 7'	PFJ	23
MP2900BK-15 (1544547)	Back Band	11/16" x 1-5/16" x 15'	PFJ	7
MP2900CB-08 (1544548)	Casing	1" x 3" x 8'	PFJ	27
MP2900CB-12 (1544549)	Casing	1" x 3" x 12'	PFJ	27
MP29111 (1544550)	Baseboard	1/2" x 4-1/8" x 16'	PFJ	11
MP29161 (1448241)	Baseboard	3/8" x 4" x 16'	PFJ	11
MP29162 (1448242)	Baseboard	3/8" x 4" x 8'	PFJ	11
MP2990BK-08 (1544556)	Back Band	3/4" x 1-1/4" x 8'	PFJ	7
MP2990BK1 (1544557)	Back Band	3/4" x 1-1/4" x 16'	PFJ	7
MP421D-08 (1544563)	Half Round	5/16" x 5/8" x 8'	PFJ	51
MP430D-08 (1544564)	Mullion	5/16" x 1-5/8" x 8'	PFJ	50
MP434D-08 (1544565)	Decorative Moulding	3/16" x 1/2" x 8'	PFJ	49
MP446-08 (1544566)	Lattice	1/4" x 11/16" x 8'	PFJ	49
MP455-08 (1544568)	Cove	15/16" x 15/16" x 8'	PFJ	33
MP466-08 (1544569)	Chair Rail	5/8" x 1-1/2" x 8'	PFJ	31
MP466-16 (1544570)	Chair Rail	5/8" x 1-1/2" x 16'	PFJ	31
MP558-07 (1544572)	Brick Mould	1-1/8" x 1-5/8" x 7'	PFJ	47
MRO12061 (1544584)	Casing	5/8" x 2-11/16" x 16'	0	23
MRO12121 (1544590)	Baseboard	3/8" x 3" x RL	0	9
MRO12122 (1448279)	Baseboard	3/8" x 3" x 8'	0	9
MRO12151 (1544593)	Baseboard	3/8" x 4-1/8" x RL	0	11
MRO12222 (1448281)	Door Stop	3/8" x 1-3/16" x 7'	0	43
MRO12312 (1510197)	Quarter Round	1/2" x 1/2" x 8'	0	51
MRO12322 (1382367)	Quarter Round	3/4" x 3/4" x 8'	0	51
MRO12342 (1328872)	Baseboard Shoe	1/2" x 3/4" x 8'	0	19

Stock Code	Profile Type	Dimensions	Species	Page
MRO12412 (1448284)	Cove	1/2" x 1/2" x 8'	0	33
MRO12422 (1328889)	Cove	11/16" x 11/16" x 8'	0	33
MRO12542 (1448287)	Corner Guard	1-1/16" x 1-1/16" x 8'	0	32
MRO12562 (1448288)	Ply Cap	3/4" x 1-1/2" x 8'	0	50
MRO12602 (1448289)	Chair Rail	9/16" x 1-3/4" x 8'	0	30
MRO12802 (1544609)	Panel Mould	5/16" x 1-5/8" x 8'	0	50
MRO12952 (1544614)	Panel Mould	3/8" x 11/16" x 8'	0	50
MRO3206 (1626639)	Quarter Round	3/4" x 3/4" x RL	0	51
MRO356 (1626652)	Casing	7/16" x 2-1/16" x 6'-16"	0	21
MRO3562 (1328910)	Casing	7/16" x 2-1/16" x 7'	0	21
MRO48-08 (1544676)	Crown	11/16" x 4-1/4" x 8'	0	39
MRO48-12 (1544677)	Crown	11/16" x 4-1/4" x 12'	0	39
MRO80581 (1544679)	Crown	9/16" x 3-3/8" x 16'	0	39
MRO825-08 (1544680)	Shingle Mould	9/16" x 1-1/8" x 8'	0	52
MSP1131-08 (1544682)	Baseboard Shoe	7/16" x 11/16" x 8'	PIN	19
MSP12032 (1448336)	Casing	3/8" x 2-1/8" x 7'	PIN	20
MSP12051 (1544685)	Casing	3/8" x 2-1/16" x 16'	PIN	21
MSP12052 (1448337)	Casing	3/8" x 2-1/16" x 7'	PIN	21
MSP12072 (1448339)	Casing	11/16" x 2-1/2" x 7'	PIN	23
MSP12091 (1544689)	Casing	9/16" x 2-3/4" x RL	PIN	23
MSP12092 (1544690)	Casing	9/16" x 2-3/4" x 7'	PIN	23
MSP12112 (1448340)	Baseboard	5/16" x 3-1/8" x 8'	PIN	8
MSP12121 (1448341)	Baseboard	5/16" x 3-1/8" x RL	PIN	9
MSP12122 (1448342)	Baseboard	5/16" x 3-1/8" x 8'	PIN	9
MSP12151 (1448343)	Baseboard	3/8" x 4" x RL	PIN	11
MSP12152 (1448344)	Baseboard	3/8" x 4" x 8'	PIN	11
MSP1219-08 (1544697)	Ply Cap	11/16" x 1-5/8" x 8'	PIN	50
MSP12212 (1448345)	Door Stop	5/16" x 1" x 7'	PIN	43
MSP12232 (1448346)	Door Stop	5/16" x 1" x 7'	PIN	42
MSP12252 (1448347)	Burlap	1/4" x 1-3/16" x 8'	PIN	47
MSP12272 (1510301)	Lattice	1/4" x 1-5/8" x 8'	PIN	49
MSP12282 (1510302)	Flat Stock	1/2" x 3/4" x 8'	PIN	45
MSP12312 (1448348)	Quarter Round	7/16" x 7/16" x 8'	PIN	51
MSP12321 (1544706)	Quarter Round	11/16" x 11/16" x 16'	PIN	51
MSP12322 (1448350)	Quarter Round	11/16" x 11/16" x 8'	PIN	51
MSP1234-12 (1544709)	Baseboard Shoe	3/8" x 11/16" x 12'	PIN	19
MSP12342 (1510305)	Baseboard Shoe	3/8" x 11/16" x 8'	PIN	19
MSP12412 (1448351)	Cove	1/2" x 1/2" x 8'	PIN	33
MSP12421 (1544712)	Cove	11/16" x 11/16" x 6'-16"	PIN	33
MSP12422 (1448353)	Cove	11/16" x 11/16" x 8'	PIN	33
MSP12512 (1448355)	Shingle Mould	9/16" x 1-1/8" x 8'	PIN	52
MSP12522 (1448356)	Shingle Mould	9/16" x 1-7/16" x 8'	PIN	52
MSP12532 (1448357)	Corner Guard	11/16" x 11/16" x 8'	PIN	32
MSP12542 (1448358)	Corner Guard	15/16" x 15/16" x 8'	PIN	32
MSP12562 (1510312)	Ply Cap	9/16" x 1-1/8" x 8'	PIN	50
MSP12601 (1544724)	Chair Rail	11/16" x 1-3/4" x RL	PIN	30
MSP12602 (1448360)	Chair Rail	11/16" x 1-3/4" x 8'	PIN	30
MSP12612 (1510313)	Half Round	5/16" x 5/8" x 8'	PIN	51
MSP12622 (1544727)	Screen Mould	1/4" x 3/4" x 8'	PIN	51
MSP356-07 (1382742)	Casing	21/32" x 2-1/4" x 7'	PIN	22
MSP706-08 (1510319)	Quarter Round	15/16" x 15/16" x 8'	PIN	51
MSP711-08 (1448365)	Crown	9/16" x 3-1/16" x 8'	PIN	34
MSP729-08 (1637783)	Crown	9/16" x 4-1/2" x 8'	PIN	34
MTEK103-08 (1544734)	Flat Stock	11/16" x 2-1/2" x 8'	COM	44
MTEK126-08 (1426891)	Baseboard Shoe	1/2" x 3/4" x 8'	COM	19
MTEK126-12 (1426890)	Baseboard Shoe	1/2" x 3/4" x 12'	COM	19

INDEX

Stock Code	Profile Type	Dimensions	Species	Page
MTEK297-08 (1544738)	Chair Rail	$\frac{1}{16}'' \times 3'' \times 8'$	COM	31
MTEK3140-08 (1329023)	Baseboard	$\frac{1}{2}'' \times 3\text{-}\frac{1}{4}'' \times 8'$	COM	14
MTEK3140-12 (1329024)	Baseboard	$\frac{1}{2}'' \times 3\text{-}\frac{1}{4}'' \times 12'$	COM	14
MTEK3206-08 (1329025)	Quarter Round	$\frac{1}{16}'' \times \frac{1}{16}'' \times 8'$	COM	51
MTEK3206-12 (1426842)	Quarter Round	$\frac{1}{16}'' \times \frac{1}{16}'' \times 12'$	COM	51
MTEK356-07 (1329027)	Casing	$\frac{7}{16}'' \times 2\text{-}\frac{1}{4}'' \times 7'$	COM	21
MTEK47-08 (1510342)	Crown	$\frac{5}{8}'' \times 4\text{-}\frac{1}{4}'' \times 8'$	COM	35
MTEK8058-08 (1544747)	Crown	$\frac{1}{2}'' \times 3\text{-}\frac{5}{16}'' \times 8'$	COM	39
MTEK8223-07 (1544749)	Jamb	$\frac{5}{8}'' \times 4\text{-}\frac{9}{16}'' \times 7'$	COM	46
MTEK8390-08 (1544750)	Chair Rail	$\frac{5}{8}'' \times 2\text{-}\frac{1}{2}'' \times 8'$	COM	30
MTEK8621-07 (1045998)	Casing	$\frac{3}{8}'' \times 2\text{-}\frac{1}{8}'' \times 7'$	COM	21
MTEK8622B-08 (1544753)	Baseboard	$\frac{3}{8}'' \times 3\text{-}\frac{1}{8}'' \times 8'$	COM	9
MTEK8622B-12 (1544754)	Baseboard	$\frac{3}{8}'' \times 3\text{-}\frac{1}{8}'' \times 12'$	COM	9
MTEK8662-07 (1544755)	Door Stop	$\frac{3}{8}'' \times 1\text{-}\frac{3}{8}'' \times 7'$	COM	42
MTEK8900-07 (1510345)	Casing	$\frac{9}{16}'' \times 2\text{-}\frac{3}{4}'' \times 7'$	COM	23
MTEK8910-08 (1008260)	Baseboard	$\frac{3}{8}'' \times 3\text{-}\frac{7}{8}'' \times 8'$	COM	10
MTEK8910-12 (1544760)	Baseboard	$\frac{3}{8}'' \times 3\text{-}\frac{7}{8}'' \times 12'$	COM	10
MTEK8954-08 (1010368)	Casing	$\frac{11}{16}'' \times 3\text{-}\frac{1}{2}'' \times 8'$	COM	24
MTEK8954-12 (1544762)	Casing	$\frac{11}{16}'' \times 3\text{-}\frac{1}{2}'' \times 12'$	COM	24
MTEK8955-08 (1008273)	Baseboard	$\frac{9}{16}'' \times 5\text{-}\frac{9}{16}'' \times 8'$	COM	16
MTEK8955-12 (1007186)	Baseboard	$\frac{9}{16}'' \times 5\text{-}\frac{9}{16}'' \times 12'$	COM	16
P251 (1544796)	Baseboard	$\frac{5}{8}'' \times 4\text{-}\frac{1}{8}'' \times \text{RL}$	PIN	11
PFP1204-16 (1544801)	Casing	$\frac{3}{4}'' \times 3\text{-}\frac{1}{2}'' \times 16'$	PRI	26
PFP1208-102 (1510358)	Casing	$\frac{3}{4}'' \times 3\text{-}\frac{1}{2}'' \times 102''$	PRI	25
PFP1208-16 (1544803)	Casing	$\frac{3}{4}'' \times 3\text{-}\frac{1}{2}'' \times 16'$	PRI	25
PFP1209-102 (1544805)	Back Band	$\frac{3}{4}'' \times 1\text{-}\frac{1}{4}'' \times 102''$	PRI	7
PFP1209-16 (1544804)	Back Band	$\frac{3}{4}'' \times 1\text{-}\frac{1}{4}'' \times 16'$	PRI	7
PFP1210-102 (1544806)	Casing	$\frac{3}{4}'' \times 2\text{-}\frac{3}{4}'' \times 102''$	PRI	24
PFP1210-16 (1544807)	Casing	$\frac{3}{4}'' \times 2\text{-}\frac{3}{4}'' \times 16'$	PRI	24
PFP1213-16 (1544808)	Casing	$\frac{3}{4}'' \times 2\text{-}\frac{13}{16}'' \times 16'$	PRI	27
PFP1214-08 (1544809)	Baseboard	$\frac{5}{8}'' \times 4\text{-}\frac{1}{4}'' \times 8'$	PRI	16
PFP1214-16 (1544810)	Baseboard	$\frac{5}{8}'' \times 4\text{-}\frac{1}{4}'' \times 16'$	PRI	16
PFP1217-08 (1544811)	Baseboard	$\frac{5}{8}'' \times 5\text{-}\frac{1}{4}'' \times 8'$	PRI	15
PFP1217-16 (1544812)	Baseboard	$\frac{5}{8}'' \times 5\text{-}\frac{1}{4}'' \times 16'$	PRI	15
PFP1222-16 (1544813)	Door Stop	$\frac{3}{8}'' \times 1\text{-}\frac{1}{4}'' \times 16'$	PRI	43
PFP1222-98 (1544813)	Door Stop	$\frac{3}{8}'' \times 1\text{-}\frac{1}{4}'' \times 98''$	PRI	43
PFP1223-16 (1544815)	Door Stop	$\frac{5}{16}'' \times 1\text{-}\frac{1}{2}'' \times 16'$	PRI	43
PFP1223-98 (1544816)	Door Stop	$\frac{5}{16}'' \times 1\text{-}\frac{1}{2}'' \times 98''$	PRI	43
PFP1224-08 (1544817)	Crown	$\frac{3}{4}'' \times 5\text{-}\frac{9}{16}'' \times 8'$	PRI	36
PFP1224-16 (1544818)	Crown	$\frac{3}{4}'' \times 5\text{-}\frac{9}{16}'' \times 16'$	PRI	36
PFP1226-16 (1544819)	Crown	$\frac{11}{16}'' \times 4\text{-}\frac{1}{4}'' \times 16'$	PRI	35
PFP1804-16 (1064431)	Casing	$\frac{11}{16}'' \times 3\text{-}\frac{1}{2}'' \times 16'$	PRI	28
PFP2102-08 (1544822)	Quarter Round	$\frac{11}{16}'' \times \frac{11}{16}'' \times 8'$	PFJ	51
PFP2102-16 (1544823)	Quarter Round	$\frac{11}{16}'' \times \frac{11}{16}'' \times 16'$	PFJ	51
PFP2112-08 (1667879)	Baseboard Shoe	$\frac{15}{32}'' \times 1\text{-}\frac{1}{2}'' \times 8'$	PRI	19
PFP2112-16 (1544824)	Baseboard Shoe	$\frac{15}{32}'' \times 1\text{-}\frac{1}{2}'' \times 16'$	PRI	19
PFP2258JD-98 (1677346)	Jamb	$\frac{11}{16}'' \times 4\text{-}\frac{5}{8}'' \times 97\text{-}\frac{11}{16}''$	PRI	46
PFP2900CB-102 (1544827)	Casing	$1'' \times 3'' \times 102''$	PRI	27
PFP2900CB-16 (1544828)	Casing	$1'' \times 3'' \times 16'$	PRI	27
PFP3414-102 (1544829)	Back Band	$\frac{3}{4}'' \times 1\text{-}\frac{1}{4}'' \times 102''$	PRI	7
PFP3414-16 (1544830)	Back Band	$\frac{3}{4}'' \times 1\text{-}\frac{1}{4}'' \times 16'$	PRI	7
PFP8230-16 (1544833)	Baseboard	$\frac{21}{32}'' \times 5\text{-}\frac{1}{4}'' \times 16'$	PRI	18
PFP8235-08 (1544834)	Baseboard	$\frac{5}{8}'' \times 7\text{-}\frac{1}{4}'' \times 8'$	PRI	17
PFP8235-16 (1544835)	Baseboard	$\frac{5}{8}'' \times 7\text{-}\frac{1}{4}'' \times 16'$	PRI	17
PFP8238-16 (1544836)	Baseboard	$\frac{5}{8}'' \times 4\text{-}\frac{1}{4}'' \times 16'$	PRI	14
PFP8239-08 (1544837)	Baseboard	$\frac{5}{8}'' \times 7\text{-}\frac{1}{4}'' \times 8'$	PRI	18

Stock Code	Profile Type	Dimensions	Species	Page
PFP8239-16 (1544838)	Baseboard	$\frac{5}{8}'' \times 7\text{-}\frac{1}{4}'' \times 16'$	PRI	18
PFP8240-16 (1544839)	Door Stop	$\frac{1}{2}'' \times 1\text{-}\frac{1}{2}'' \times 16'$	PRI	43
PFP8319-16 (1064405)	Baseboard	$\frac{5}{8}'' \times 5\text{-}\frac{1}{2}'' \times 16'$	PRI	18
PFP8321-16 (1064411)	Baseboard	$\frac{5}{8}'' \times 7\text{-}\frac{1}{4}'' \times 16'$	PRI	18
PFP8322-16 (1637785)	Baseboard	$\frac{5}{8}'' \times 7\text{-}\frac{1}{4}'' \times 16'$	PRI	12
PFP8345-16 (1645261)	Casing	$\frac{3}{4}'' \times 3\text{-}\frac{1}{2}'' \times 16'$	PRI	25
PFP8954-102 (1544844)	Casing	$\frac{11}{16}'' \times 3\text{-}\frac{1}{2}'' \times 102''$	PRI	24
PFP8954-16 (1544845)	Casing	$\frac{11}{16}'' \times 3\text{-}\frac{1}{2}'' \times 16'$	PRI	24
PFP8955-08 (1544846)	Baseboard	$\frac{9}{16}'' \times 5\text{-}\frac{9}{16}'' \times 8'$	PRI	16
PFP8955-16 (1544847)	Baseboard	$\frac{9}{16}'' \times 5\text{-}\frac{9}{16}'' \times 16'$	PRI	16
PFP9093-102 (1637786)	Casing	$\frac{3}{4}'' \times 3\text{-}\frac{1}{2}'' \times 102''$	PRI	28
PFP9093-16 (1544848)	Casing	$\frac{3}{4}'' \times 3\text{-}\frac{1}{2}'' \times 16'$	PRI	28
PFP9293-16 (1544849)	Baseboard	$\frac{5}{8}'' \times 5'' \times 16'$	PRI	13
PFP9393-16 (1637787)	Baseboard	$\frac{5}{8}'' \times 6\text{-}\frac{1}{2}'' \times 16'$	PRI	13
POP12101 (1544859)	Casing	$\frac{3}{4}'' \times 2\text{-}\frac{3}{4}'' \times \text{RL}$	POP	24
POP12102 (1544861)	Casing	$\frac{3}{4}'' \times 2\text{-}\frac{3}{4}'' \times 90''$	POP	24
POP12111 (1544862)	Baseboard	$\frac{11}{16}'' \times 5\text{-}\frac{1}{2}'' \times 16'$	POP	18
POP1214-12 (1544865)	Baseboard	$\frac{5}{8}'' \times 4\text{-}\frac{1}{4}'' \times 12'$	POP	16
POP1222-07 (1544867)	Door Stop	$\frac{3}{8}'' \times 1\text{-}\frac{1}{4}'' \times 7'$	POP	43
POP1235-08 (1544869)	Baseboard Shoe	$\frac{1}{2}'' \times \frac{7}{8}'' \times 8'$	POP	19
POP1237-08 (1544871)	Quarter Round	$\frac{3}{4}'' \times \frac{3}{4}'' \times 8'$	POP	51
POP1245-12 (1544875)	Crown	$\frac{11}{16}'' \times 4\text{-}\frac{1}{4}'' \times 12'$	POP	39
POP2990-08 (1544884)	Back Band	$\frac{3}{4}'' \times 1\text{-}\frac{3}{8}'' \times 8'$	POP	7
POP3264-08 (1544886)	Cove	$\frac{11}{16}'' \times \frac{11}{16}'' \times 8'$	POP	33
V102S (1448607)	Quarter Round	$\frac{11}{16}'' \times \frac{11}{16}'' \times 8'$	PVC	51
V106S (1448608)	Cove	$\frac{3}{4}'' \times \frac{3}{4}'' \times 8'$	PVC	33
V110S (1448609)	Casing	$\frac{3}{8}'' \times 2\text{-}\frac{1}{8}'' \times 7'$	PVC	20
V130S (1448610)	Baseboard	$\frac{3}{8}'' \times 3\text{-}\frac{1}{8}'' \times 8'$	PVC	8
V15S (1544918)	Lattice	$\frac{1}{4}'' \times 1\text{-}\frac{1}{2}'' \times 8'$	PVC	49
V170S (1448611)	Corner Guard	$\frac{3}{4}'' \times \frac{3}{4}'' \times 8'$	PVC	32
V2900S (1544921)	Casing	$\frac{5}{8}'' \times 2\text{-}\frac{3}{4}'' \times 86''$	PVC	23
V601S (1510770)	Casing	$\frac{9}{16}'' \times 2\text{-}\frac{1}{8}'' \times 7'$	PVC	20
V606S (1510771)	Baseboard	$\frac{3}{8}'' \times 2\text{-}\frac{15}{16}'' \times 8'$	PVC	9
V70S (1448615)	Door Stop	$\frac{3}{8}'' \times 1\text{-}\frac{1}{4}'' \times 7'$	PVC	43



EXPLORE OTHER PRODUCTS FROM METRIE®

In addition to our vast profile assortment, we offer unique product solutions that make it easy to select and install millwork.



Coordinated Collections of interior moulding and doors that are professionally designed to ensure harmonious proportions, timeless beauty and perfect scale.



Curated moulding & interior door combinations that complement today's top décor trends.



Pre-painted & ready to install moulding solution that allows you to finish before you start.



Quality interior doors distributed with Metrie moulding, simplifies ordering and delivery.



METRIE® IS NORTH AMERICA'S LEADING MANUFACTURER AND DISTRIBUTOR OF INTERIOR FINISHINGS.

Our industry position has allowed us the resources, strength and leadership to create solutions that make it easier for consumers and design professionals to select, purchase and design with interior mouldings and doors.

Metrie products distributed by:



390 CHRYSLER DRIVE
BRAMPTON, ON L6S 5Z5
T: 905.792.1144 F: 905.792.8306

8100 PARKHILL DRIVE
MILTON, ON L9T 5V7

© 2019 Metrie MET-480-ONT_0319 Printed in Canada

METRIE.COM